

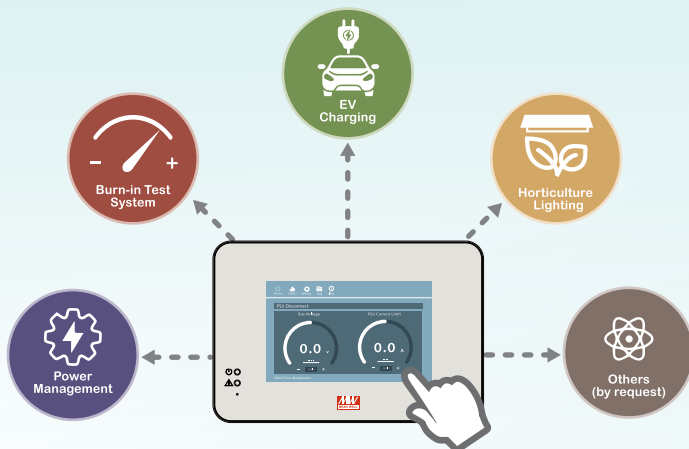

# CMU2C Installation manual



*Multi-Industry General Purpose Smart Controller*

• Programmable • Intelligent • Smart UI

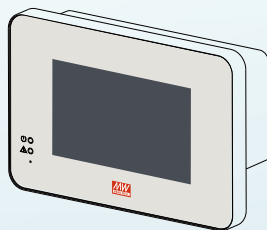
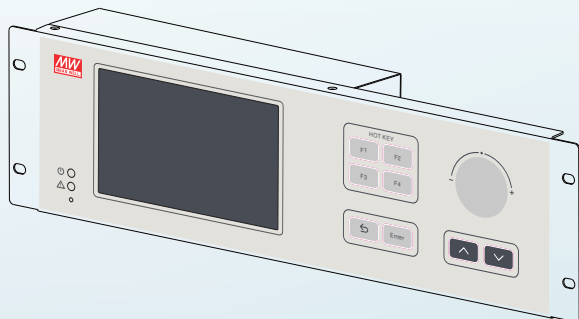

CMU2C is a fully digitalized smart controller that can execute tasks of monitoring and controlling over power system. It can be accessed through local/remote and wired connection. With four built-in configurable relay contacts, users can flexibly monitor specific events or alarms and take suitable action accordingly. It not only being used to monitor the operating parameters and data of PSUs such as output voltage, output current, internal temperature, fan rpm, series number and firmware version, but also can be used to adjust output voltage and current. In addition, it can remotely control single PSU or entire power system through LAN or internet.

# Index

<b>1.Safety Guidelines</b>	1	<b>6.Maintenance</b>	79
1.1 Passwords	1	6.1 Firmware update instruction	79
<b>2.Introduction</b>	2	<b>7.Warranty</b>	81
2.1 Model Encoding	2		
2.2 Features	2		
2.3 Specification	3		
2.4 Mechanical Specification	4		
2.5 Supported Models	7		
<b>3.Installation &amp; Wiring</b>	7		
3.1 Installation	7		
3.2 Configuration	9		
3.3 SD Card Installation	10		
<b>4.User Interface</b>	14		
4.1 Panel Description	14		
4.2 LED indication	15		
4.3 Pin assignment of CN38	16		
4.4 Pin assignment of CN39	17		
4.5 Pin assignment of TB1	18		
4.6 Pin assignment of TB30	19		
4.7 Pin assignment of JK51	20		
4.8 Pin assignment of JK52	21		
4.9 Pin assignment of JK22	22		
<b>5.Operation</b>	23		
5.1 Touch panel	23		
5.2 Web-based User Interface	47		
5.3 MODBus TCP Interface	63		

# 1.Safety Guidelines

- Risk of electrical shock and energy hazard, all failure should be examined by a qualified technician. Please do not remove the case from the bidirectional power supply by yourself.
- Please do not install the supply in places with high moisture, high ambient temperature or under direct sunlight.
- The AC voltage range is 85 – 265Vac (47 – 63Hz), please do not connect the unit to AC gird out of the range.
- The safety protection level of this supply is class I. The “Frame Ground” (≡) of the unit must be well connected to PE (Protective Earth).
- Do not use sharp objects or tools in the vicinity of the LCD touch panel.
- Treat the LCD carefully to prevent puncture, bursting, or cracking of the screen.
- If the LCD is damaged and any liquid comes in contact with your skin, immediately rinse the area with running water for at least 15 minutes. If the liquid gets in your eyes, immediately rinse your eyes with running water for at least 15 minutes and consult a doctor.

## 1.1 Passwords

Password is required to edit network settings. The following is the default password for the interfaces:

Touch panel interface: The password is entered when selecting System in Setting page.

- By default, the password is “CMU2C” .

# 2.Introduction

## 2.1 Model Encoding

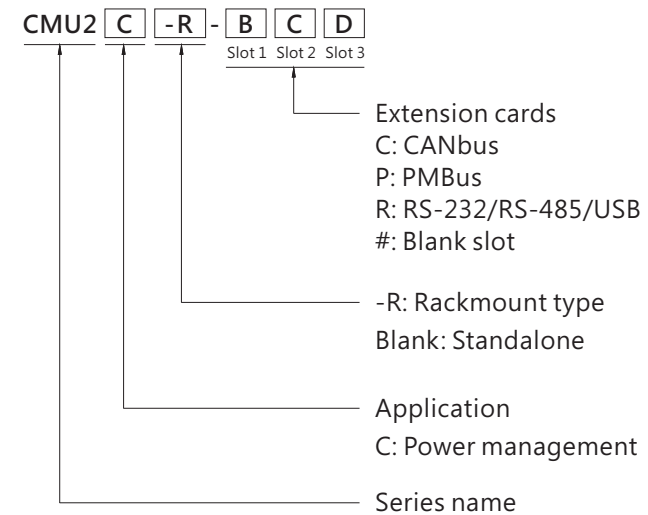

## 2.2 Features

- Integration on system power
- 2 models in 3U 19-inch rack-mount and standalone configurations
- 7" touch panel and buttons for easy operation on-site operation
- Ethernet port for on-site or remote monitor and control over the system
- Selectable PMBus and CAN bus communication protocols
- Support Data/ Event log with date and time
- Support max. 32G SDHC SD card
- Support firmware upgrade
- Four user programmable relay outputs for conventional remote monitoring or warning
- Web-based monitor/control UI provided for various applications
- 5 years warranty

## 2.3 Specification

MODEL (Note.8)		CMU2C	CMU2C-R
OUTPUT	LCD DISPLAY	Display the DC output voltage, current, and status of each PSU	
	LED INDICATOR	Green: Power on/ Normal Red: Fault/ Abnormal	
	RELAY CONTACT	Note.4	4 user programmable channels, 30V/1A
	ANALOG OUTPUT	Note.4	5 user programmable channels, 0-10V
	DIGITAL OUTPUT	Note.4	5 user programmable channels, open collector signal
INPUT	VOLTAGE RANGE	85 ~ 264VAC; 120-370VDC	
	FREQUENCY RANGE	47 ~ 63Hz	
	CURRENT	0.6A / 115VAC	0.4A / 230VAC
	ANALOG INPUT	Note.4	5 Channels, 0-10V, 12bit resolution
	DIGITAL INPUT	Note.4	5 Channels, open collector signal
FUNCTION	MONITORED	I/P & O/P Voltage, O/P current, temperature, fan rpm	
	COMM. INTERFACE	Note.1	PMBus, CANbus
	SD CARD SLOT	SDHC 32GB Max.	
	FIRMWARE UPDATE	Update can be done via SD card or Ethernet access	
	UI LANGUAGE	English, Traditional/Simplified Chinese	
	LOG	Record data and events	
	BUZZER	Alarms, mute Button click & alarms, mute	
COMMUNICATION PROTOCOLS	PMBUS	Note.4	PMBus v1.1
	CANBUS	Note.4	CANbus 2.0B
	NETWORK	Support IEEE802.3, 10/100base network	
	EXTENSION CARDS	Note.1	Extension Cards
ETHERNET SUPPORTED	PROTOCOLS	TCP/IP, NTP, SMTP, Modbus TCP	
	WEB SERVER	Display status of system, parameters, data being logged or download	
EXTENSION CARDS	PMBUS	Note.7	2 PMBus ports, PMBus V1.1
	CANBUS	Note.7	2 CANBus ports, CANBus 2.0B
	USB/RS-232/RS-485	2 USB ports, RS-232 port, RS-485 port	
DISPLAY	LCD PANEL	Note.2	7" TFT LCD, resolution 800x480, capacitive touch panel Details of settings please refer to user's manual
ENVIRONMENT	WORKING TEMP.	Note.2	-25 ~ +60°C
	STORAGE TEMP.	-40 ~ +60°C	
	VIBRATION	10 ~ 500Hz, 2G 10min./1cycle, 60min. each along X, Y, Z axes	
SAFETY & EMC (Note 4)	SAFETY STANDARDS	IEC62368-1, BS EN/EN62368-1 approved	
	WITHSTAND VOLTAGE	Note.3	I/P-O/P:3KVAC I/P-FG:2KVAC O/P-FG:0.7KVDC
	ISOLATION RESISTANCE	Note.3	O/P-FG:100M Ohms / 500VDC / 25°C / 70% RH
	EMC EMISSION	Compliance to BS EN/EN55032 (CISPR32) Conduction Class B, Radiation Class A ; BS EN/EN61000-3-2,-3	
EMC IMMUNITY	Compliance to BS EN/EN61000-4-2,3,4,5,6,8,11, BS EN/EN61000-6-1(BS EN/EN50082-2), light industry level, criteria A		
OTHER	MTBF	680K hrs min. Telcordia TR/SR-332 (Bellcore) ; 75.9K hrs min. MIL-HDBK-217F (25°C)	
	DIMENSION	245*70*164.2mm (L*W*H)	483.6*66.3*132mm (L*W*H)
	PACKING	1.68Kg; 8pcs/14.4Kg/2.14CUFT	2.16Kg; 6pcs/14Kg/2.91CUFT
NOTE	1. Depend on application. 2. LCD may freeze under -20°C. 3. CN36, CN37 are considered as O/P. 4. All functions of signal connectors: DIN/DOUT, AIN/AOUT, Relay, RS-232, RS-485, PMBus, CANBus are defined by application. Please check installation manual for detail. 5. The controller is considered a component which will be installed into a final equipment. EMC is tested by the controller unit, no control equipment is connected. The final equipment must re-confirmed that still meets EMC directives. For guidance on how to perform these EMC test, Please refer to "EMI testing of component power supplies" (as available on <a href="https://www.meanwell.com/Upload/PDF/EMI_statement_en.pdf">https://www.meanwell.com/Upload/PDF/EMI_statement_en.pdf</a> ) 6. The RTC power supply used super capacitors, which can last for only 7 days. If the time exceeds the limit, the RTC date must be re-adjusted. 7. Up to 40 power supplies can be operate in parallel connection, and possible up to 48 power supplies. 8. Order model only CMU2C-P##, CMU2C-R-P##, CMU2C-C##, CMU2C-R-C## and optional CMU2A-#R# available. ※ Product Liability Disclaimer : For detailed information, please refer to <a href="https://www.meanwell.com/serviceDisclaimer.aspx">https://www.meanwell.com/serviceDisclaimer.aspx</a>		

## 2.4 Mechanical Specification

### Standalone type

Unit:mm

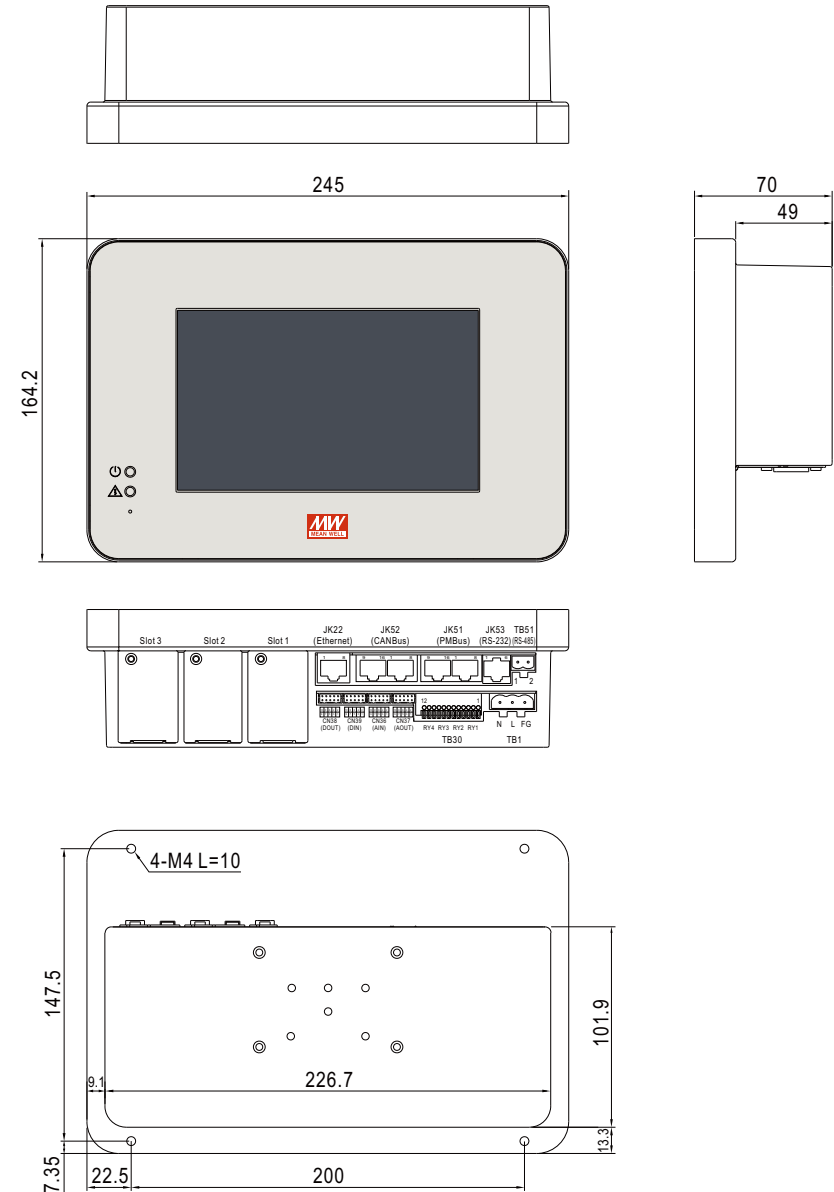

# Rack-mount typ

Unit:mm

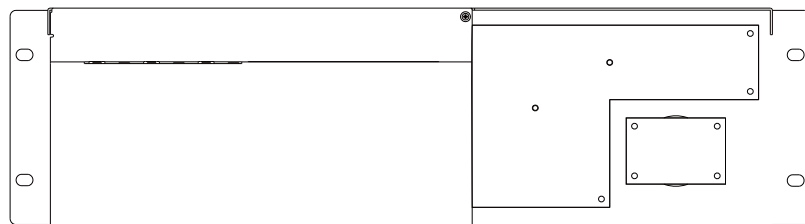
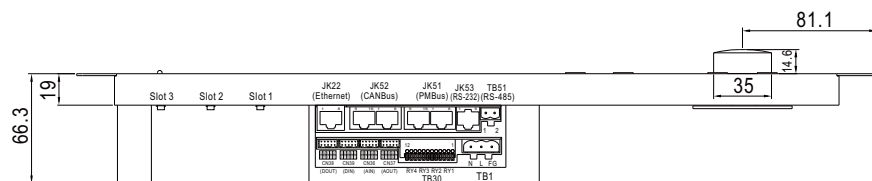
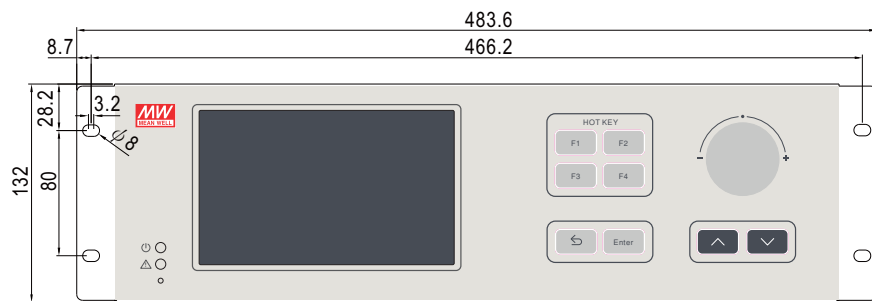

## Extension cards

※ PMBus(P card)

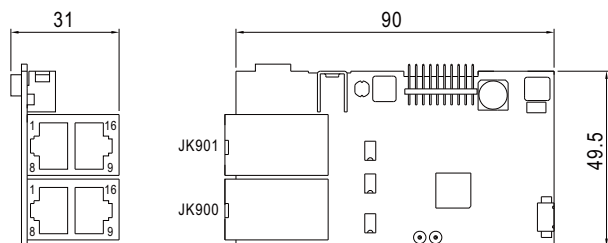

※ PMBus(C card)

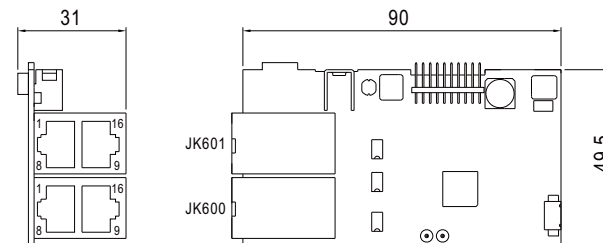

※ RS-232/RS485/USB(R card)

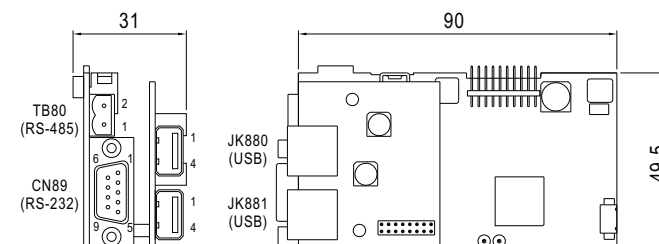

## Accessory (Standalone type only)

①	1GG2DRP14A	
②	1GG2MHS094	

Note: 1GG2DRP14A is suitable for installation on TS35/7.5 or TS35/15 rail

## 2.5 Supported Models

Model	Supported series
CMU2C-P## CMU2C-R-P##	DRP-3200, HEP-2300PM, NCP-3200, PHP-3500, PHP-3500HV, RCP-1600, SHP-10KPM, SHP-30KPM
CMU2C-C## CMU2C-R-C##	DRP-3200CAN, HEP-2300CAN, NCP-3200CAN, PHP-3500CAN, PHP-3500HVCAN, RCP-1600CAN, SHP-10K, SHP-30K, BIC-2200

## 3. Installation & Wiring

### 3.1 Installation

#### 3.1.1 Standalone Type

##### 3.1.1.1 Wall Mounting

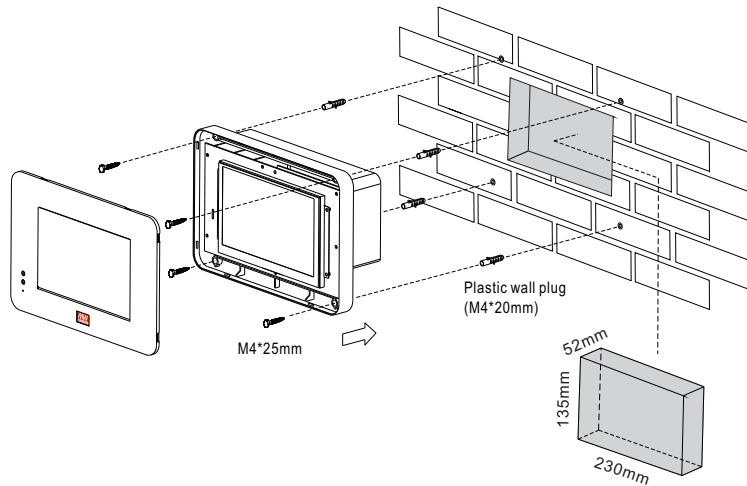

##### 3.1.1.2 Accessory Installation

##### Din Rail

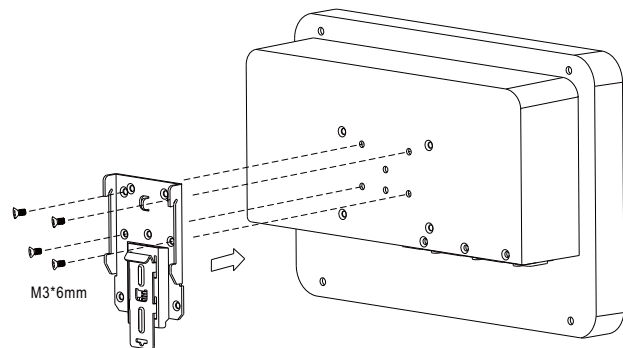

7

### Desktop

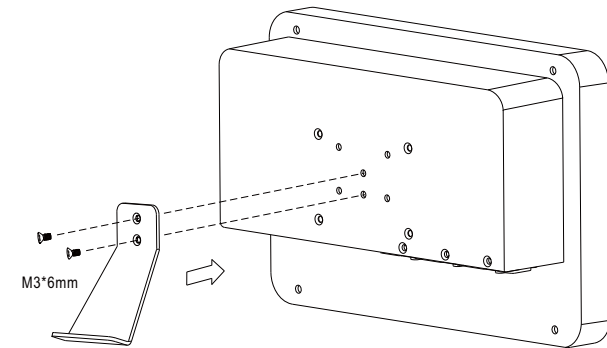

##### 3.1.2 Rack-mount type

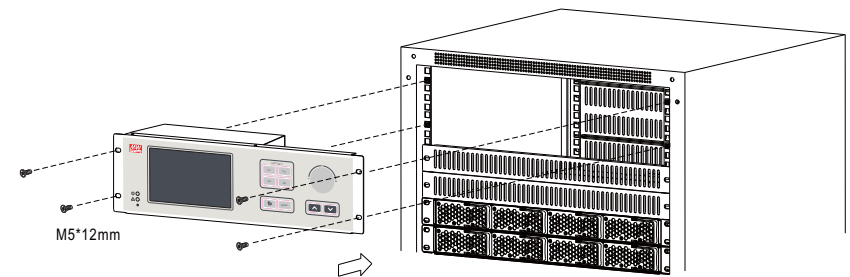

8

## 3.2 Configuration

The CMU2 is able to recognize up to three communication ports for PMBus or CAN bus device addressing, a single communication port can recognize a maximum of 64 device addresses, each port recognized as an independent group. Before connecting rack powers to a communication port of the CMU2, please make sure these units have their unique and own device address to prevent communication issues caused by duplicate addressing. Locations of these three ports are illustrated below, devices connected to port A will be assigned and displayed address 0 – 63; port B will be address 64 – 127; port C will be address 128 – 191.

PMBus version Port: JK51, Port: JK900 and Port: JK901

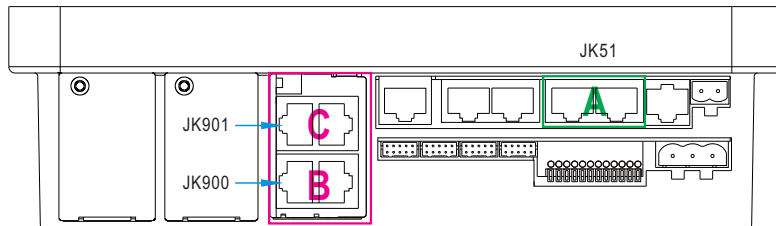

CANBus version Port: JK52, Port: JK600 and Port: JK601

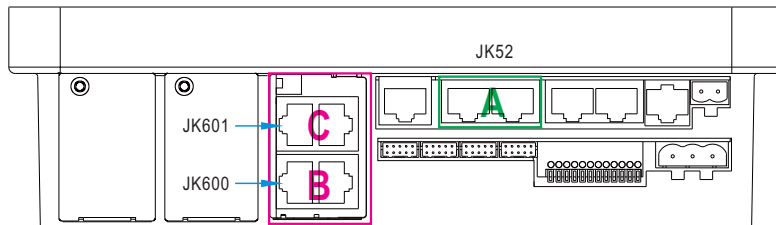

Note: If there are less than 64 devices connected to the communication port, the vacant address will display disconnect.

For example: connect 8 units of DRP-3200 to the port B and designate the addresses of these 8 devices as 0-7. Then on the CMU2, it will only display 64-71 online, the remaining 0-63 and 72-191 will be displayed disconnect.

## 3.3 SD Card Installation

CMU2 supports SDHC type SD cards with capacity of 4G - 32G

### Standalone type

- ① Before installing a SD card, please remove the top cover of the standalone version, the top cover is locked by 8 clips.

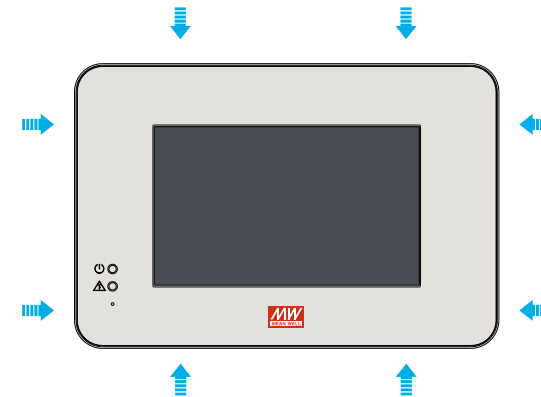

- ② The 8 clips can be released with a flat-blade screwdriver. After inserting the flat-head screwdriver into the gap between the top cover and the body, apply a little force to unlock the clips.

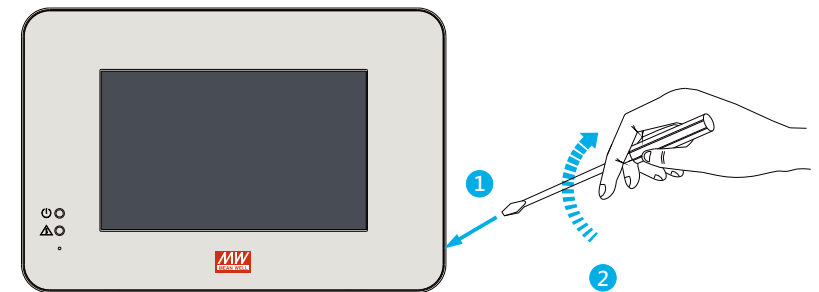



③ After the top cover is removed, please follow the steps below to insert a SD card. After a SD card is inserted, please reinstall the cover.

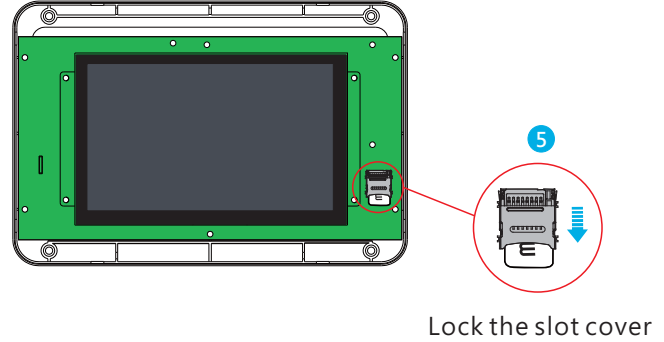
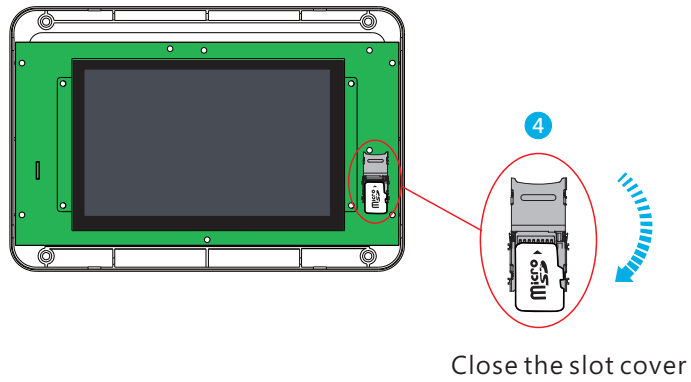
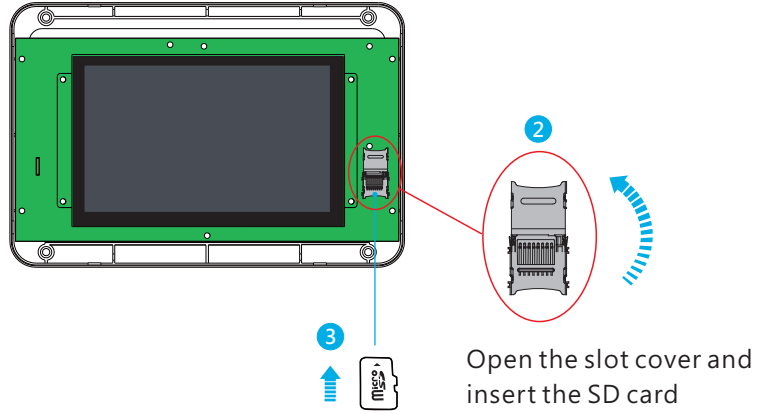
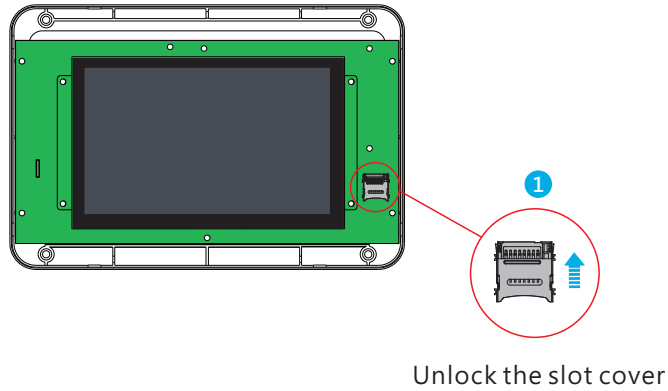

Rack-mount type

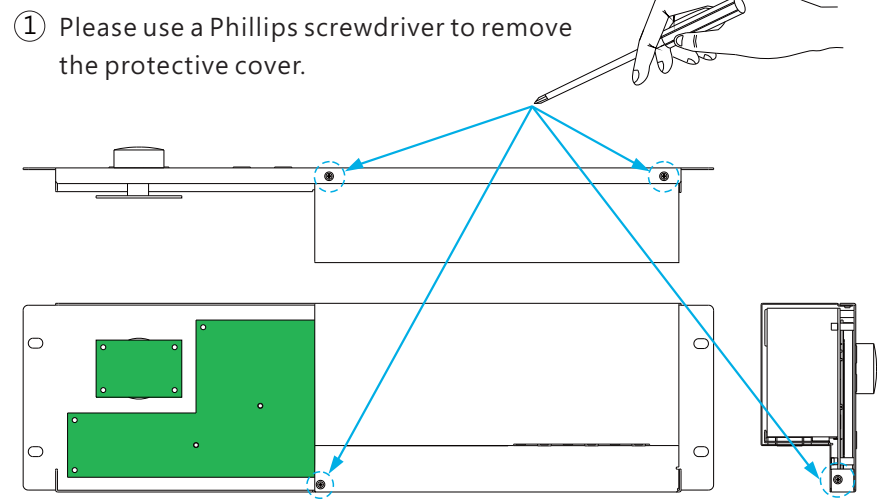

② After the cover is removed, please follow the steps below to insert a SD card. After a SD card is inserted, please reinstall the cover.

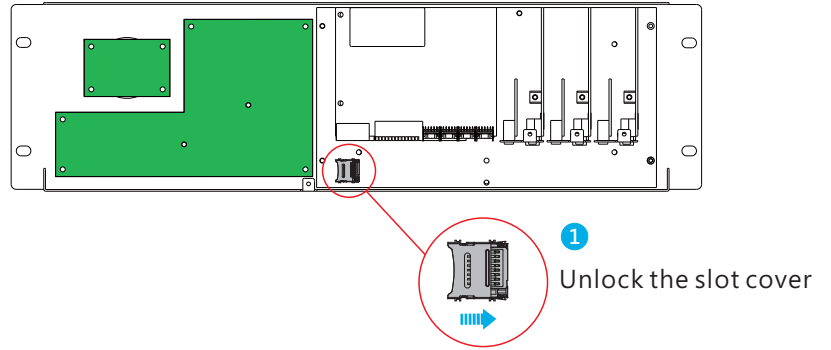

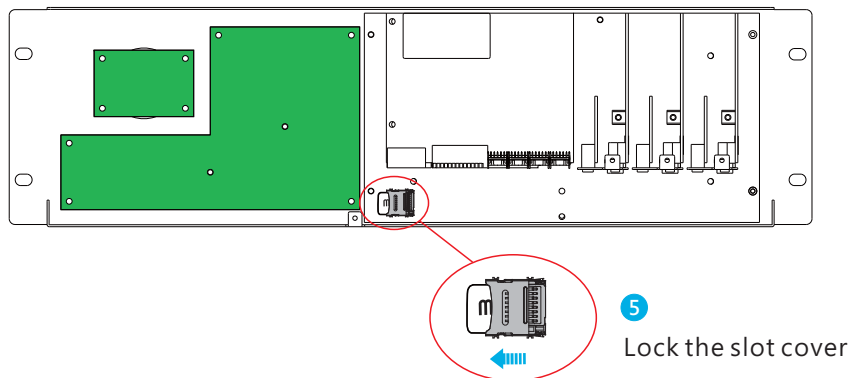
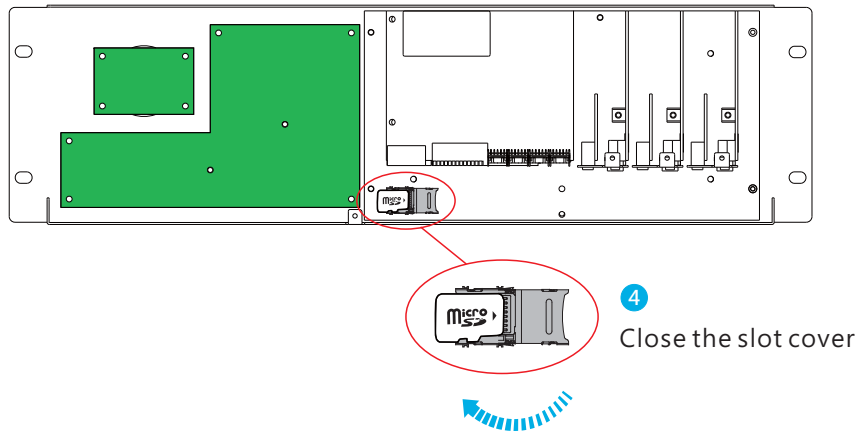
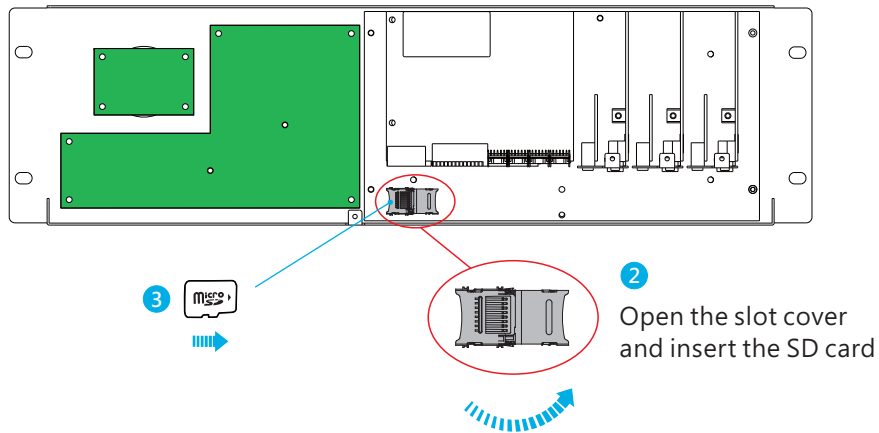

## 4. User Interface

### 4.1 Panel Description

- Ⓐ **Power indicator:**  
Used to display whether the CMU is powered on.
- Ⓑ **Alarm indicator:**  
Used to display operation status of the CMU2.
- Ⓒ **Touch panel:**  
Tap to select functional pages.
- Ⓓ **Hotkey buttons:**  
Press F1~F4 to enter the specific pages. F1: Home page; F2: event log page; F3: PUS on/off page; F4: Output voltage/current adjustment page.
- Ⓔ **Knob:**  
Used to quickly adjust values, turning clockwise to increase the value and turning anti-clockwise to decrease it. This function is only valid in Output voltage/current adjustment page.
- Ⓕ **Up and down buttons:**  
The up and down buttons are used to jump to output voltage and current adjustment page. It can work with the Knob to quickly adjust a required value. This function is only valid in the output adjustment page.
- Ⓖ **Enter and return buttons:**  
In Output voltage/current adjustment page, you can use the enter button to apply a value that is adjusted by the Knob or use the return button to jump back to the home page.
- Ⓗ **Reset button:**  
Press to reset the CMU2.

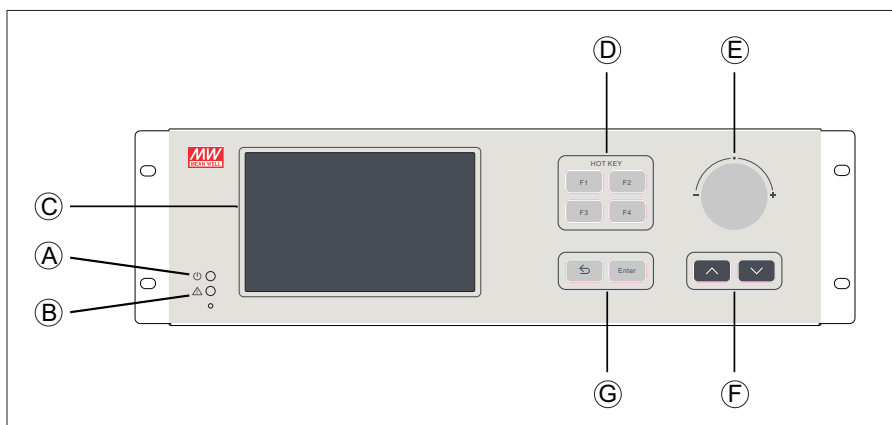
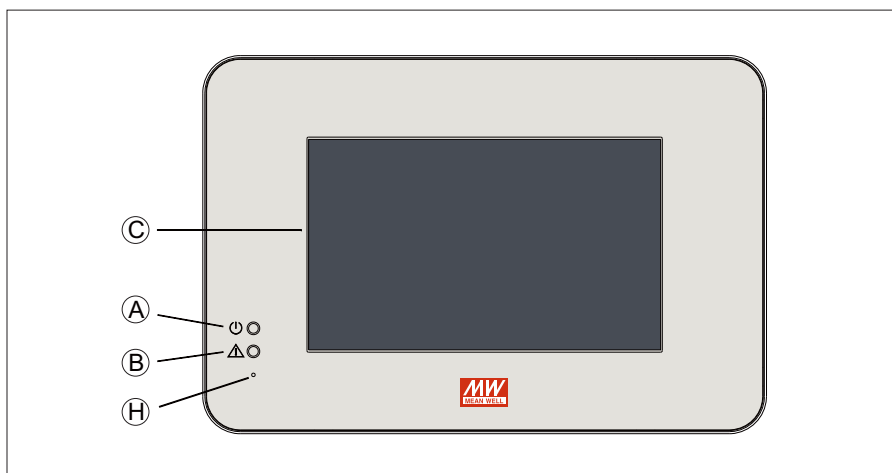

## 4.2 LED indication

LED	Status	Description
	Green	Power indication, constant green when power on.
	Red (flashing)	CMU2 or Rack Power in abnormal conditions.
	No indication	Normal working.

## 4.3 Pin assignment of CN38

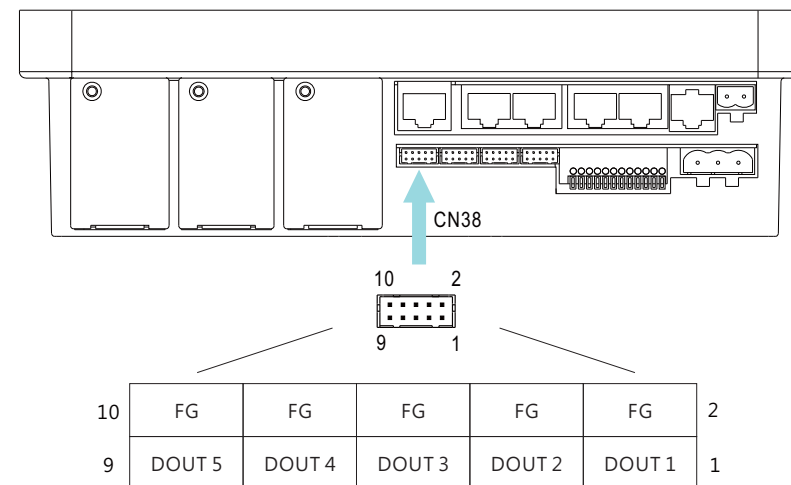

Pin No.	Function	Description
1	DOUT 1	The isolated digital output signal with FG as reference Open collector signal, Max. signal voltage is 5V with FG as reference
2,4,6,8,10	FG	Common FG for DOUTx
3	DOUT 2	The isolated digital output signal with FG as reference Open collector signal, Max. signal voltage is 5V with FG as reference
5	DOUT 3	
7	DOUT 4	
9	DOUT 5	

#### 4.4 Pin assignment of CN39

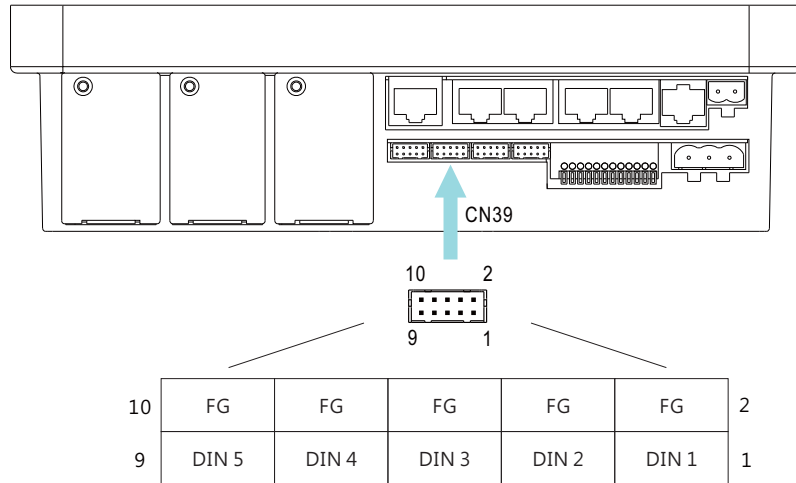

Pin No.	Function	Description
1	DIN 1	The isolated digital input signal with FG as reference Open collector signal Open from F4 or +5V: Logic "1" input to CMU2 Short to FG or 0V: Logic "0" input to CMU2
2,4,6,8,10	FG	Common FG for DINx
3	DIN 2	The isolated digital input signal with FG as reference Open collector signal, Max. signal voltage is 5V with FG as reference
5	DIN 3	
7	DIN 4	
9	DIN 5	

#### 4.5 Pin assignment of TB1

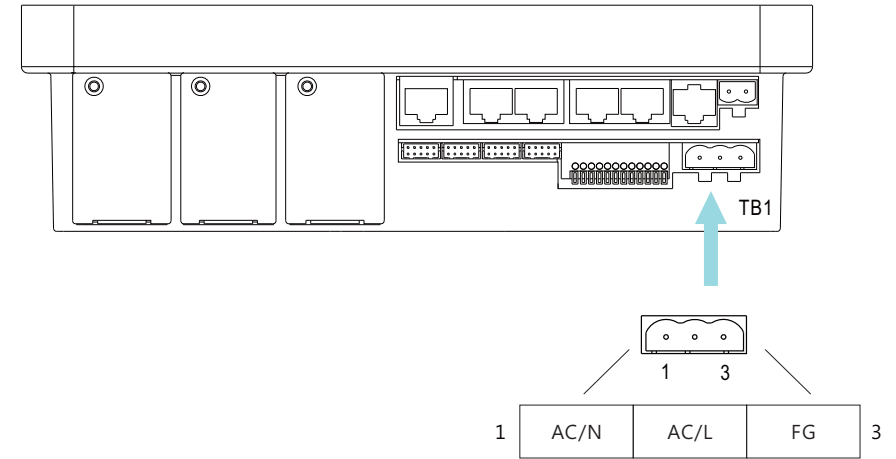

Pin No.	Function	Description
1	AC/N	AC input neutral wire
2	AC/L	AC input live wire
3	FG	FG wire

## 4.6 Pin assignment of TB30

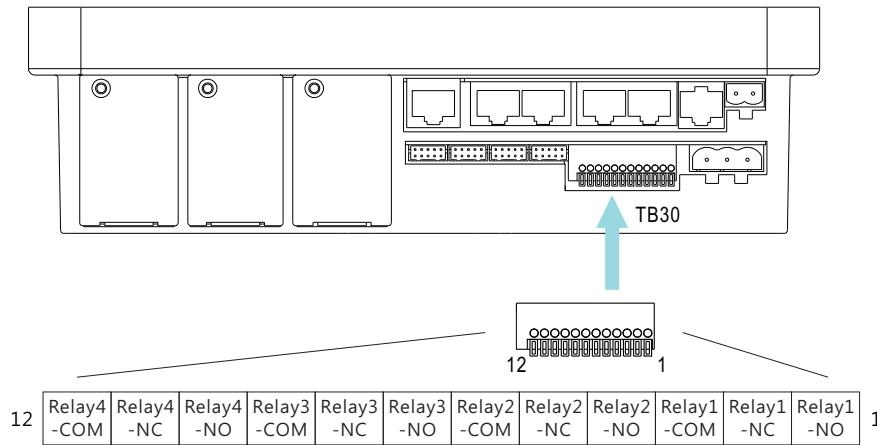

Pin No.	Function	Description
1	Relay1-NO	Normal-open contact of programmable relay1
2	Relay1-NC	Normal-close contact of programmable relay1
3	Relay1-COM	Common for relay1 NO/NC contact
4	Relay2-NO	Normal-open contact of programmable relay2
5	Relay2-NC	Normal-close contact of programmable relay2
6	Relay2-COM	Common for relay2 NO/NC contact
7	Relay3-NO	Normal-open contact of programmable relay3
8	Relay4-NC	Normal-close contact of programmable relay3
9	Relay3-COM	Common for relay3 NO/NC contact
10	Relay4-NO	Normal-open contact of programmable relay4
11	Relay4-NC	Normal-close contact of programmable relay4
12	Relay4-COM	Common for relay4 NO/NC contact

## 4.7 Pin assignment of JK51

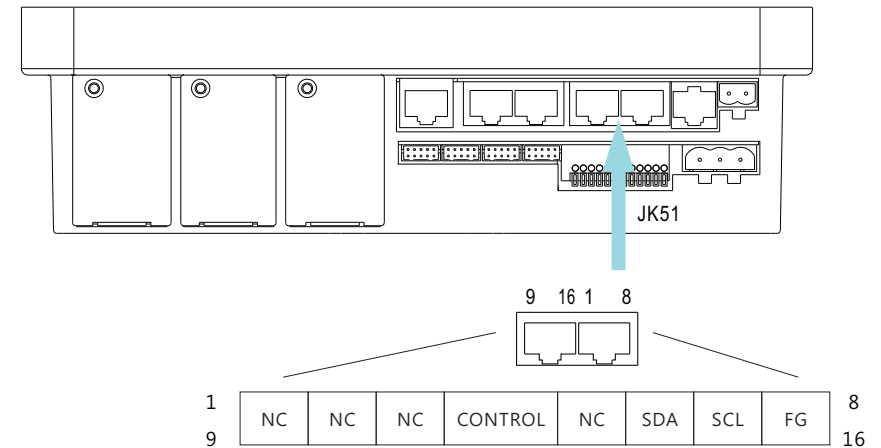

Pin No.	Function	Description
1,2,3,5,9, 10,11,13	NC	Not use
4,12	CONTROL	Remote ON/OFF control pin (Note)
6,14	SDA	Serial Data used in the PMBus interface (Note)
7,15	SCL	Serial Clock used in the PMBus interface (Note)
8,16	FG	Common FG for signal

Note: Isolated signal, with FG as reference

## 4.8 Pin assignment of JK52

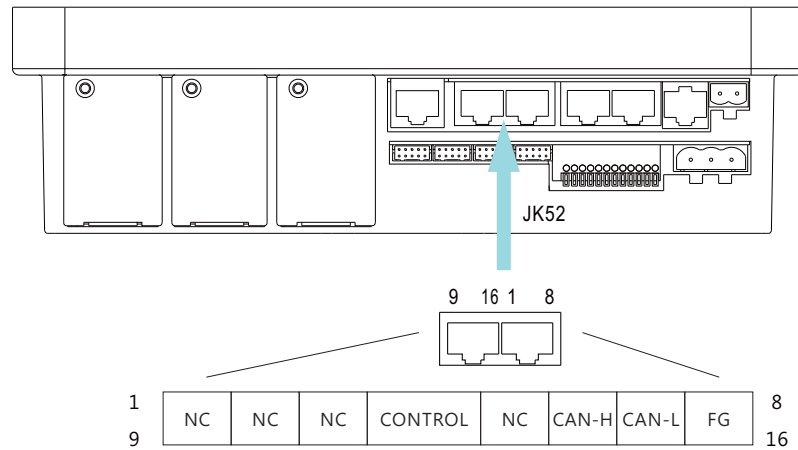

Pin No.	Function	Description
1,2,3,5,9,10,11,13	NC	Not use
4,12	CONTROL	Remote ON/OFF control pin (Note)
6,14	CAN-H	CAN-H used in the CAN Bus interface (Note)
7,15	CAN-L	CAN-L used in the CAN Bus interface (Note)
8,16	FG	Common FG for signal

Note: Isolated signal, with FG as reference

## 4.9 Pin assignment of JK22

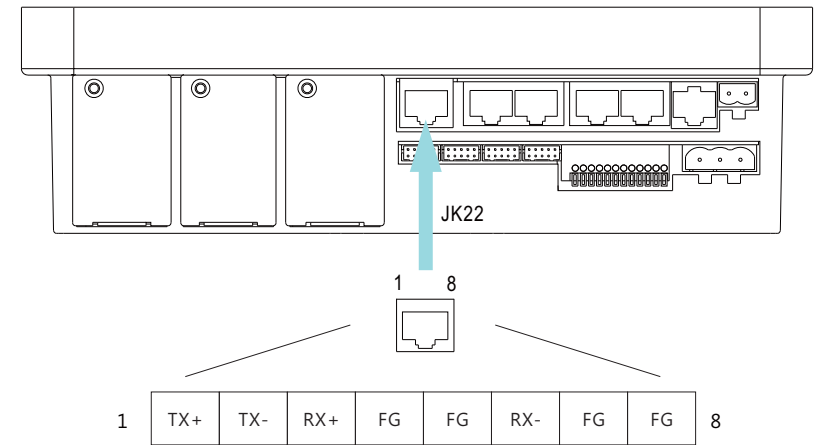

Pin No.	Function	Description
1	TX+	Transmit data used in the Ethernet interface
2	TX-	Transmit data used in the Ethernet interface
3	RX+	Receive data used in the Ethernet interface
4,5,7,8	FG	Common FG for signal
6	RX-	Receive data used in the Ethernet interface

## 5.Operation

The CMU2 communicates with rack powers via PMBus and CANBus interfaces to achieve operation monitoring and remote control functions of system power. In addition, CMU2 supports communication interfaces of touch panel and network. Through these interfaces, CMU2 can integrate the management of system power, as shown in the picture below. Detailed information about the functions, please refer to the following chapters.

\*Up to 40 units of DRP-3200 can be operated in parallel connection and the controller is able to communicate with 48 devices through the bus.

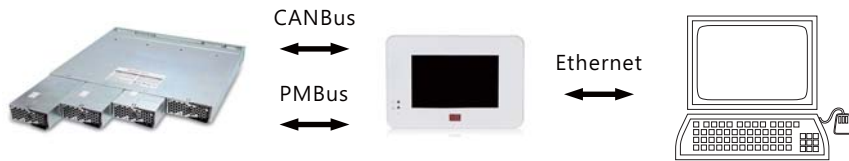

### 5.1 Touch panel





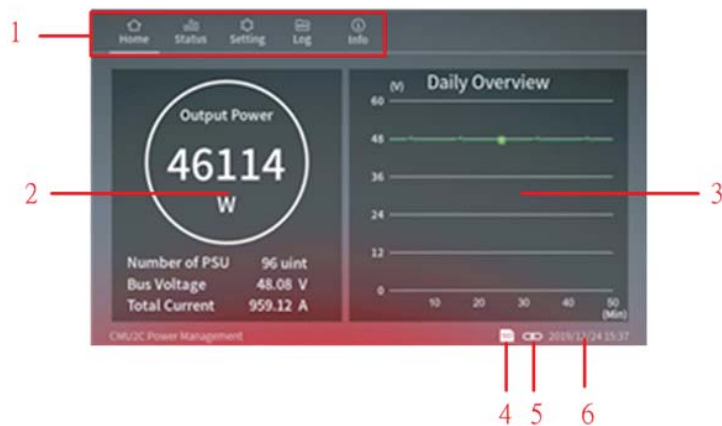

#### 5.1.1 Home page

After power on, the CMU2 will enter the home page automatically. In the home page, the CMU2 displays the current status of the rack power units, including output power, number of PSU, bus voltage, total current and real-time operation curve, etc. Users can also tap the menu bar above to enter into other pages.



### Home page – options

The following functions are available in the home page:

No.	Name	Description
1	Menu bar 	Users can enter other function pages by taping the menu bar. There are Home, Status, Setting, Log and Info menus available. The Menu displayed on the screen will be underlined. 
2	Power information 	Output Power: displays total wattage Number of PSU: displays numbers of PSUs connected to the CMU2 (the host*64+one extension card 64*2= max 192) Bus Voltage: displays the current voltage setting Total Current: displays the sum of devices' current.
3	Real time operation curve 	CMU2 records bus voltage values every 60 seconds and displays them on the curve. Note: When switching to other pages, the curve will be reset and restarted again.
4	SD card icon 	This icon is used to display whether there is a SD card connected. The SD card icon appears if there is a SD card detected.
5	Network icon 	This icon is used to display whether the network is connected. The icon appears if connected to the network.
6	Date and time	Displays date and time.

### 5.1.2 Status

Status page displays operation status of PSU, I/O signal and Relays.

#### 5.1.2.1 PSU

PSU page displays status of PSUs connected. Information includes address number, current, operation status, model name, serial number, firmware version, internal temperature, fan speed, etc.





#### PSU page - options

The following functions are available in the PSU page:

No.	Name	Description
1	Page selection 	<p>1) Users can tap  to select a desired page to display. There are twelve pages in total as below:</p> <p>01/12: PSU address 0 – 15                      02/12: PSU address 16 – 31                      03/12: PSU address 32 – 47                      04/12: PSU address 48 – 63                      05/12: PSU address 64 – 79                      06/12: PSU address 80 – 95                      07/12: PSU address 96 – 111                      08/12: PSU address 112 – 127                      09/12: PSU address 128 – 143                      10/12: PSU address 144 – 159                      11/12: PSU address 160 – 175                      12/12: PSU address 176 – 191</p>

No.	Name	Description
		<p>2)After tapping , it becomes twenty four pages because more information added and displays as below:</p> <p>01/24: PSU address 0 – 7                      02/24: PSU address 8 – 15                      03/24: PSU address 16 – 23                      04/24: PSU address 24 – 31                      05/24: PSU address 32 – 39                      06/24: PSU address 40 – 47                      07/24: PSU address 48 – 55                      08/24: PSU address 56 – 63                      09/24: PSU address 64 – 71                      10/24: PSU address 72 – 79                      11/24: PSU address 80 – 87                      12/24: PSU address 88 – 95                      13/24: PSU address 96 – 103                      14/24: PSU address 104 – 111                      15/24: PSU address 112 – 119                      16/24: PSU address 120 – 127                      17/24: PSU address 128 – 135                      18/24: PSU address 136 – 143                      19/24: PSU address 144 – 151                      20/24: PSU address 152 – 159                      21/24: PSU address 160 – 167                      22/24: PSU address 168 – 175                      23/24: PSU address 176 – 183                      24/24: PSU address 184 – 191</p>

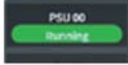
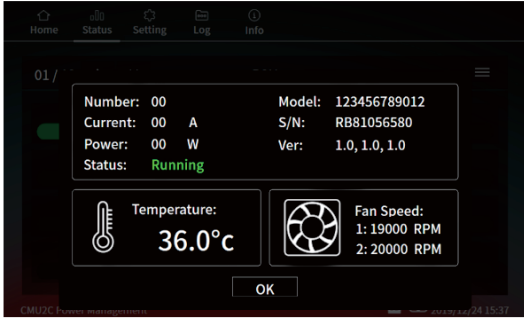

No.	Name	Description																																													
2	PSU operation status 	<p>1) These information boxes are used to display online and operation status of the PSUs. There are four conditions: Running, Error, Remote off and Disconnect. Running: Normal working Error: The PSU is in an abnormal condition Remote off: No PSU connected or PSU off</p> <p>2) Tapping a specific PSU can display more information of the unit, including serial number, firmware version, internal temperature, fan speed, etc.</p> 																																													
3	Change the display method 	<p>1) After tapping the icon, there are voltage, current and power adding to the box.</p> <table border="1" data-bbox="461 1027 972 1241"> <thead> <tr> <th>PSU</th> <th>Voltage</th> <th>Current</th> <th>Power</th> <th>Status</th> </tr> </thead> <tbody> <tr> <td>00</td> <td>220.17 V</td> <td>130.44 A</td> <td>32768 W</td> <td>Running</td> </tr> <tr> <td>01</td> <td>220.17 V</td> <td>130.44 A</td> <td>32758 W</td> <td>Error</td> </tr> <tr> <td>02</td> <td>220.17 V</td> <td>130.44 A</td> <td>32758 W</td> <td>Remote Off</td> </tr> <tr> <td>03</td> <td>--</td> <td>--</td> <td>--</td> <td>Disconnect</td> </tr> <tr> <td>04</td> <td>--</td> <td>--</td> <td>--</td> <td>Disconnect</td> </tr> <tr> <td>05</td> <td>--</td> <td>--</td> <td>--</td> <td>Disconnect</td> </tr> <tr> <td>06</td> <td>--</td> <td>--</td> <td>--</td> <td>Disconnect</td> </tr> <tr> <td>07</td> <td>--</td> <td>--</td> <td>--</td> <td>Disconnect</td> </tr> </tbody> </table> <p>2) In the mode, you also can display more PSU information by tapping a specific PSU.</p>	PSU	Voltage	Current	Power	Status	00	220.17 V	130.44 A	32768 W	Running	01	220.17 V	130.44 A	32758 W	Error	02	220.17 V	130.44 A	32758 W	Remote Off	03	--	--	--	Disconnect	04	--	--	--	Disconnect	05	--	--	--	Disconnect	06	--	--	--	Disconnect	07	--	--	--	Disconnect
PSU	Voltage	Current	Power	Status																																											
00	220.17 V	130.44 A	32768 W	Running																																											
01	220.17 V	130.44 A	32758 W	Error																																											
02	220.17 V	130.44 A	32758 W	Remote Off																																											
03	--	--	--	Disconnect																																											
04	--	--	--	Disconnect																																											
05	--	--	--	Disconnect																																											
06	--	--	--	Disconnect																																											
07	--	--	--	Disconnect																																											

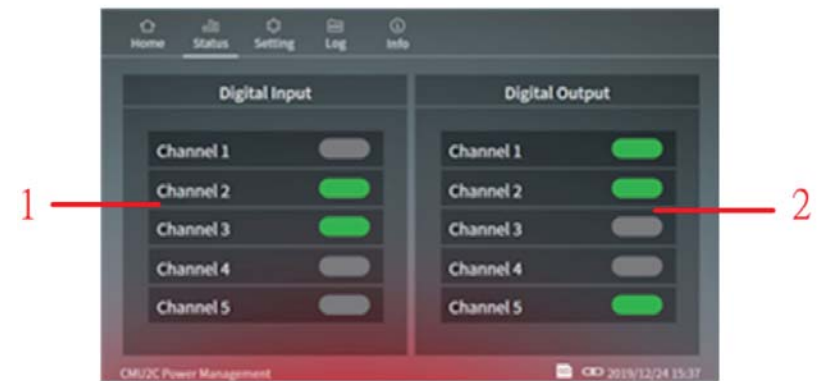

### 5.1.2.2 I/O signal

I/O signal page displays digital status of inputs and outputs. There are 5 channels each.



### I/O signal page - options

The following functions are available in the I/O signal page:

No.	Name	Description
1	Digital input status 	There are 2 conditions, it displays green when logic high whereas it displays gray when logic low. It remains logic high when no signal connected due to hardware design.
2	Digital output status 	<p>There are 2 conditions where the status turns green:</p> <ul style="list-style-type: none"> <li>The trigger condition is met &amp; Active logic is set at High.</li> <li>The trigger condition is NOT met &amp; Active logic is set at Low.</li> </ul> <p>There are 2 conditions where the status stays gray:</p> <ul style="list-style-type: none"> <li>The trigger condition is met &amp; Active logic is set at Low.</li> <li>The trigger condition is NOT met &amp; Active logic is set at High.</li> </ul>

### 5.1.2.3 Relay

The relay page is used to display output state and setting parameters of the four programmable relays.

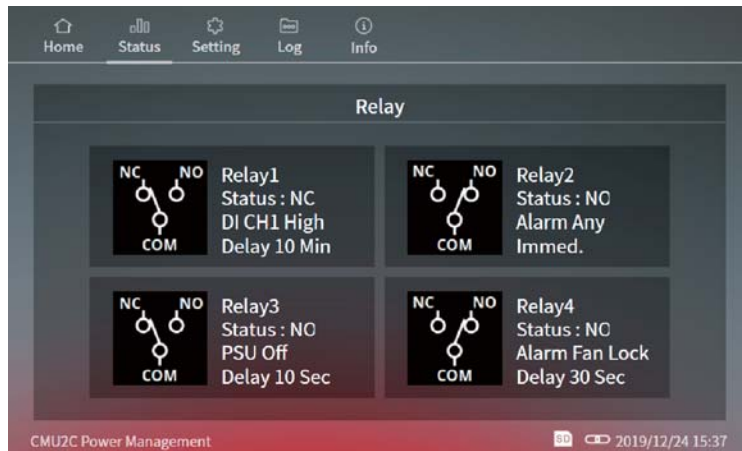

#### Relay page– options

The following functions are available in the Relay page:

There are up to 285 permutations according to different trigger conditions. Trigger selection is shown as below:

	Trigger	Delay
Alarm	Any, OVP, Short, OTP, AC-Fail, Fan Lock	Immed., 1Sec, 5Sec, 10Sec, 30Sec, 1~10Min
PSU	ON, OFF	
DI CH1 –DI CH5	High, Low	

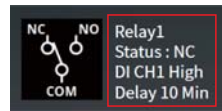

There are 2 status, if the trigger condition is met, it will display NO (Normal Open), the icon is COM connected to NO; if the trigger condition is not met, it will display NC (Normal Close), the icon is COM connected to NC

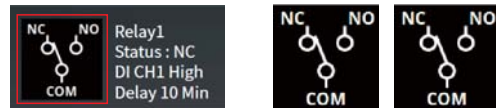

### 5.1.3 Setting

The Setting page can do settings of PSU on/off, Output adj, I/O signal, Relay and System.

Detailed information about the functions, please refer to following section.

#### 5.1.3.1 PSU on/off



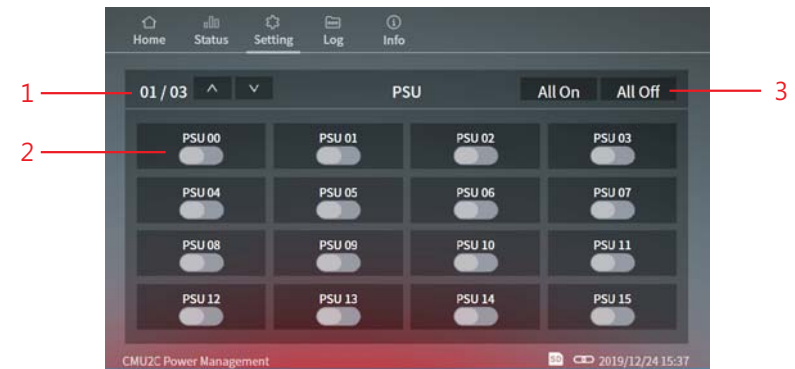

PSU on/off page provides users the ability to turn on/off the PSUs, including all PSUs on/off and single PSU unit on/off.

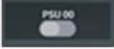

#### PSU on/off page – options

The following functions are available in PSU on/off page:

No.	Name	Description
1	Page selection	<p>1) Users can tap  to select a desired page to display. There are twelve pages in total as below:</p> <p>01/12: PSU address 0 – 15                      02/12: PSU address 16 – 31                      03/12: PSU address 32 – 47                      04/12: PSU address 48 – 63                      05/12: PSU address 64 – 79                      06/12: PSU address 80 – 95                      07/12: PSU address 96 – 111                      08/12: PSU address 112 – 127                      09/12: PSU address 128 – 143                      10/12: PSU address 144 – 159                      11/12: PSU address 160 – 175                      12/12: PSU address 176 – 191</p>

No.	Name	Description
2	Single PSU on/off 	Tap specific PUS to control its on/off state. Take PSU00 as an example:  PSU00 ON  PSU00 OFF
3	All PSU on/off 	To turn all PSUs on/off at the same time. Note: If PSU is not online, you cannot control it



### 5.1.3.2 Output adj



The output adj page provides functions to set output voltage and current. It also displays maximum and minimum adjustable values for user convenience.



#### Output adj page – options

The following functions are available in output adj page:

No.	Name	Description
1	Model	Display model name of the rack power
2	Voltage adjustment 	1) Use the slider bar  to adjust the output voltage. Tapping $\pm$ buttons can fine adjust the voltage in 0.1V unit. After choosing a desired voltage value, tap  to write your new voltage setting. 2) It will return to the current setting value if no any action is taken. Note: Voltage setting cannot exceed voltage limitation of the rack power. Taking DRP-3200-48 as an example is 24 – 60V

No.	Name	Description
3	Current adjustment 	1) Use the slider bar  to adjust the output current. Tapping $\pm$ buttons can fine adjust the current in 0.1A unit. After choosing a desired current value, tap  to write your new current setting. 2) It will return to the current setting value if no any action is taken. Note: Current setting cannot exceed current limitation of the rack power. Taking DRP-3200-48 as an example is 13.5 – 73.5A

### 5.1.3.3 I/O signal

I/O signal page is used to set five digital output channels to realize alarm functions you need.

In addition, the channels also can work with digital inputs to do further applications.

Digital Output	Source	Trigger	Active	Delay
Channel 1	Alarm	Any	High	Immed.
Channel 2	PSU	On	Low	10 Min
Channel 3	DI CH4	High	High	30 Sec
Channel 4	Alarm	Fan Lock	High	Immed.
Channel 5	PSU	Off	Low	1 Min

Each digital output channel can flexibly set a source, a trigger definition, an action and a delay. After tapping an output channel, triggering options will appear. Please refer to the table below for detailed triggering functions.

Source	Trigger	Active	Delay
Alarm	Any	High	Immed.
Alarm	Any	High	Immed.
Alarm	Any	High	Immed.



Source	Trigger	Active	Delay
Alarm (default)	Any (default), OVP, OLP, Short, OTP, AC-Fail, Fan Lock	High (default), Low	Immed.(default) · 1Sec · 5Sec · 10Sec · 30Sec · 1~10Min
PSU	On, Off		
DI CH1 - DI CH5	High, Low		

Source:

Alarm, PSU or digital input channels are available to be selected. After selection, the corresponding trigger conditions will appear. For instance: trigger definitions will move to relevant protection options for the rack powers when alarm is selected.

Trigger definitions:

- (1) Alarm: trigger the output channel when one of the supplies meets alarm conditions, such as OVP, OLP, short circuit or any of the protections (default).
- (2) PSU:
  - I. PSU ON: trigger the output channel if one of the supplies is running
  - II. PSU OFF: trigger the output channel if one of the supplies is remote off or in alarm conditions.
  - III. PSU OFF: trigger the output channel if all of the supplies are disconnect.
- (3) DI CH1 – CH5 (digital input channels): trigger the output channel according to condition of the selected input channel.

Active:

Determine the logic level when outputting. High (high level): 5V; Low (low level): 0V.

Delay:

Determine how long to delay before outputting when the trigger condition is met. There are imminently (default), 1Sec ... 10Min available.

### 5.1.3.4 Relay

Relay page is used to set four programmable relays to realize alarm functions you need.

In addition, the relays also can work with digital inputs to do further applications.

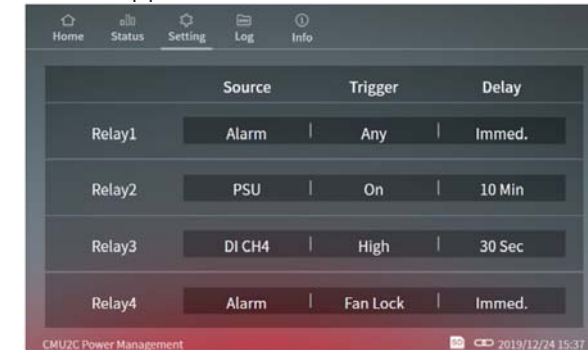

Each relay can flexibly set a source, a trigger definition and a delay. After tapping a relay, triggering options will appear. Please refer to the table below for detailed triggering functions.



Source	Trigger	Delay
Alarm (default)	Any (default), OVP, OLP, Short, OTP, AC-Fail, Fan Lock	Immed.(default) · 1Sec · 5Sec · 10Sec · 30Sec · 1~10Min
PSU	On, Off	
DI CH1 - DI CH5	High, Low	

The COMMON is connected to the NO (Normally Open) when the trigger condition is met (shown as the right picture); The COMMON is connected to the NC (Normally Closed) when the trigger condition is NOT met (shown as the left picture).

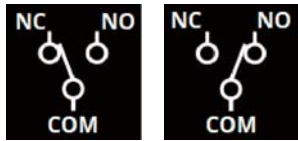

Source:

Alarm, PSU or digital input channels are available to be selected. After selection, the corresponding trigger conditions will appear. For instance: trigger definitions will move to relevant protection options for the rack powers when alarm is selected.

Trigger definition:

- (1) Alarm: trigger the output channel when one of the supplies meets alarm conditions, such as OVP, OLP, short circuit or any of the protections (default).
- (2) PSU:
  - I. PSU ON: trigger the relay if one of the supplies is running
  - II. PSU OFF: trigger the relay if one of the supplies is remote off or in alarm conditions.
  - III. PSU OFF: trigger the relay if all of the supplies are disconnect.
- (3) DI CH1 – CH5(digital input channels): trigger the relay according to condition of the selected input channel.

Delay:

Determine how long to delay before triggering the relay when the trigger condition is met. There are imminently (default), 1Sec ... 10Min available.

#### 5.1.3.5 System

System page provides settings for Network, Notice, Security, log Config, Misc and Utility. Password is required to enter the menu, the default password is "CMU2C" .

#### 5.1.3.5.1 Network

You can set the IP address on this page. The new settings will take effect after power recycling.

Address	Default
IP address	169.254.1.1
Subnet mask	255.255.0.0
Default gateway	169.254.1.1

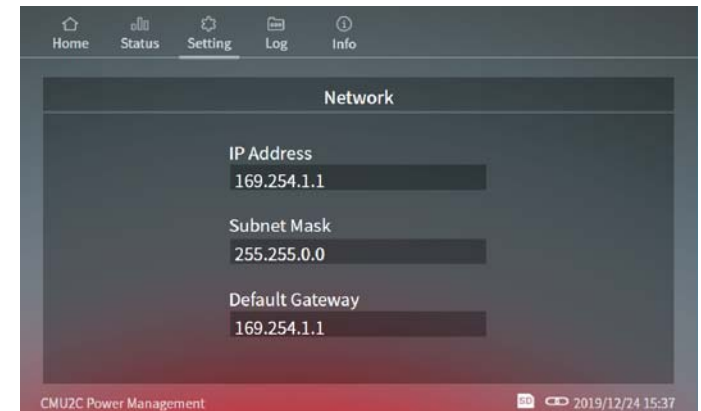

#### 5.1.3.5.2 Notice

The CMU2 can send emails to notify users when the system power is abnormal so that the issue can be investigated.

Sever IP: Set the IP address of SMTP server

User Name: Edit your user name (max 25 words)

Password: Edit your password for the SMTP (max 25 words)

Send to: Up to five emails can be set (max 25 words each)

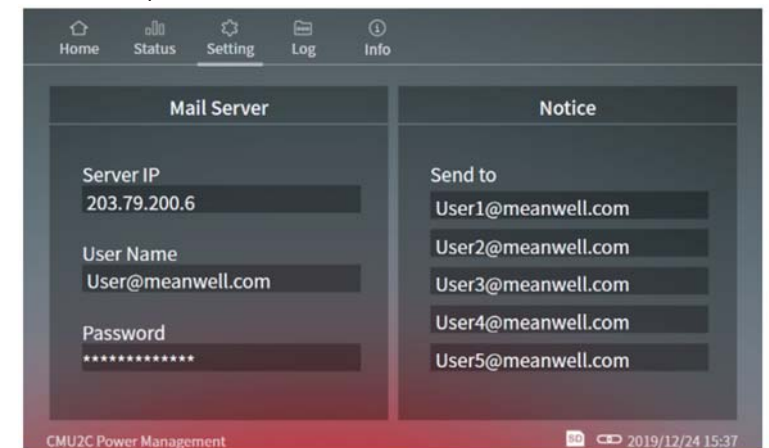

Note:

- (1) Up to 5 emails can be sent at a time, the next email will be sent after one has been sent.
- (2) The maximum content of a single mail is 3000 bytes.
- (3) Retransmission mechanism for transmission failure is 3 times, with 10min time interval.
- (4) Email sends when there is any new event log that occurs.

Email sample:



5.1.3.5.3 Security

You can change your password in this page, with max 15 words.

Please input the old and new passwords and then tap Apply to change the password.

The default password: CMU2C.

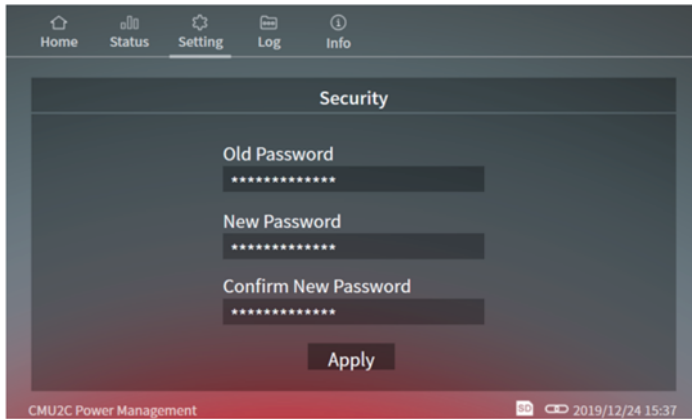

5.1.3.5.4 Screen

This page provides functions for setting turn off time for the screen and brightness.

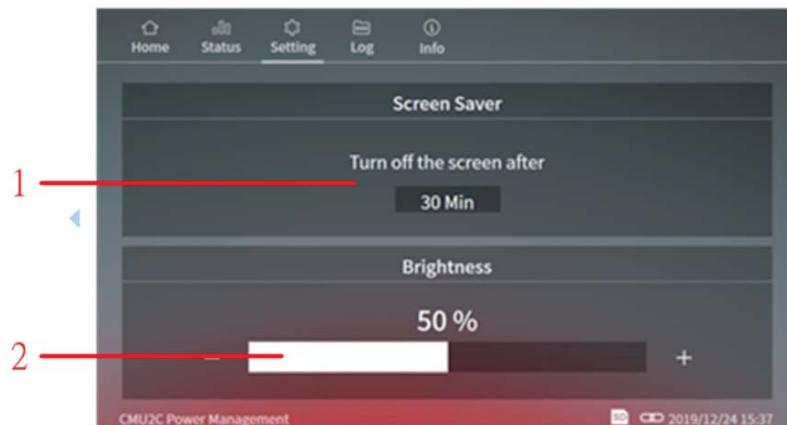

Screen page – options

The following functions are available in screen page:

No.	Name	Description
1	Screen saver	Tap the box to select a certain time to turn off the screen. There are 8 options: 1Min, 5Min, 10Min, 20Min, 30Min, 1Hr, 2Hr and Never. (Default: Never)
2	Brightness	There are 10 options for brightness setting, 10% - 100%. (Default: 50%)

5.1.3.5.5 Log Config.

Log config. page provides relevant settings for data log and event log, including data log interval, clear data log and clear event log.

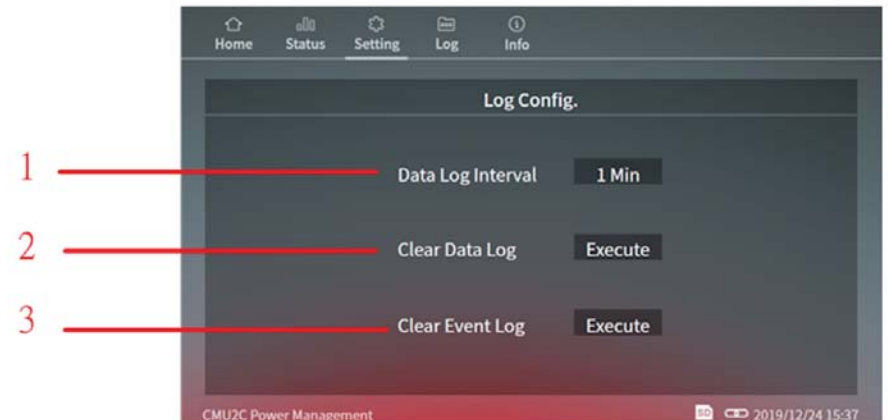

## Log Config. page – options

The following functions are available in Log Config. page:

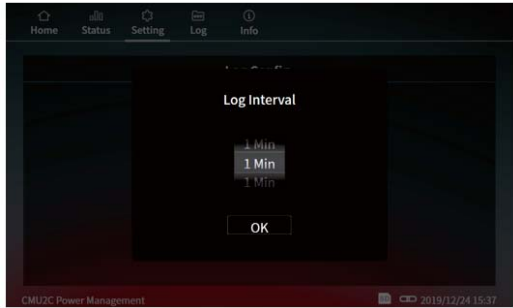
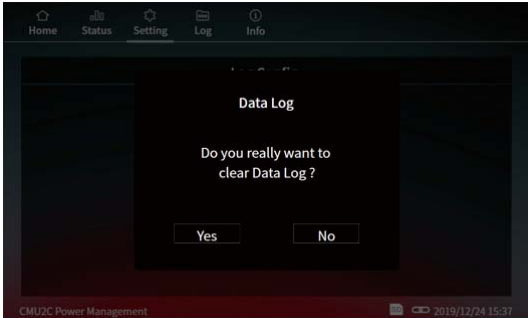
No.	Name	Description
1	Data log interval	<p>Tap the box to select a certain interval to record operation data of the rack powers. There are 9 options: 1Min, 2Min, 5 Min, 10 Min, 20 Min, 30 Min, 40 Min, 50Min, 1Hr. (Default: 1Min)</p> 
2	Clear Data Log	<p>This function is used to delete the saved data log permanently. Tap "Execute" then "Yes" to remove the data.</p> 

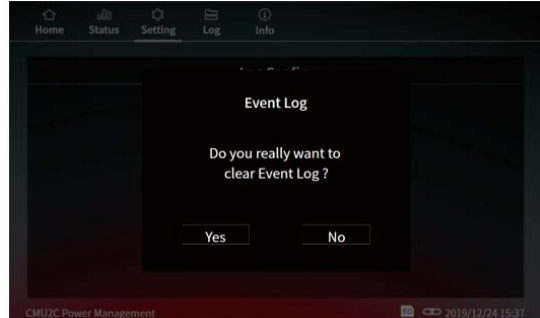
No.	Name	Description
3	Clear Event Log	<p>This function is used to delete the saved event log permanently. Tap "Execute" then "Yes" to remove the data.</p> 

### 5.1.3.5.6 Misc.





This page provides settings for Date & Time, language selection, buzzer enabling and SD card formatting.

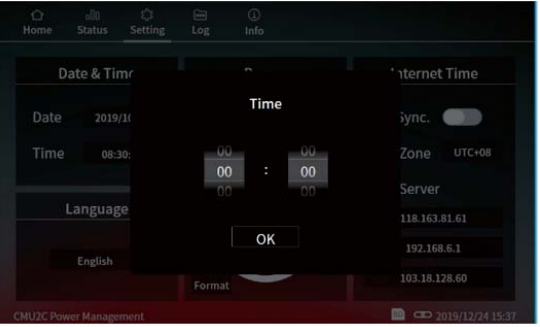

## Misc. page – options

The following functions are available in Log Misc. page:

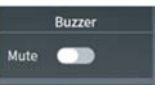
No.	Name	Description
1	Date & Time	<p>Tapping the boxes can change the date and time.</p> <p>Date setting:</p>  <p>Time setting:</p>  <p>Note: Settings for Date &amp; Time becomes invalid when auto-synchronization with internet time is enabled.</p>

No.	Name	Description
2	Synchronization with internet time	<p>1) Choose whether to synchronize the clock with an internet time.</p>  <p>2) There are 25 options for time zone selection, UTC-12 - UTC+12. (Default: UTC+08)</p> <p>3) Up to 3 internet time servers available to be set, using IP addresses. (Default: Time Server 1 : 118.163.81.61 &lt;TW&gt; Time Server 2 : 114.118.7.163 &lt;CN&gt; Time Server 3 : 82.161.251.125 &lt;EU&gt;)</p>
3	Language selection	<p>There are English, Traditional Chinese and Simplified Chinese selectable.</p>  
4	Buzzer enabling	<p>When mute is disabled, a blue switch is displayed; when mute is enabled, a gray switch is displayed (Default: disabled)</p>  

Note: The CMU2 utilises a super capacitor as an energy source to drive the internal clock while power off. The date & time will return to default setting when the capacitor runs flat. We suggest synchronising the clock with an internet time to calibrate the time automatically, if not possible turn on the CMU2 to recharge the capacitor at least once every three days.



No.	Name	Description
5	SD card formatting	It displays the SD card capacity and usage information. Tap "Execute" then "Yes" to format the SD card.



#### 5.1.3.5.7 Utility

This page displays firmware versions of the system host, communication and extension cards and provides the factory resetting function.

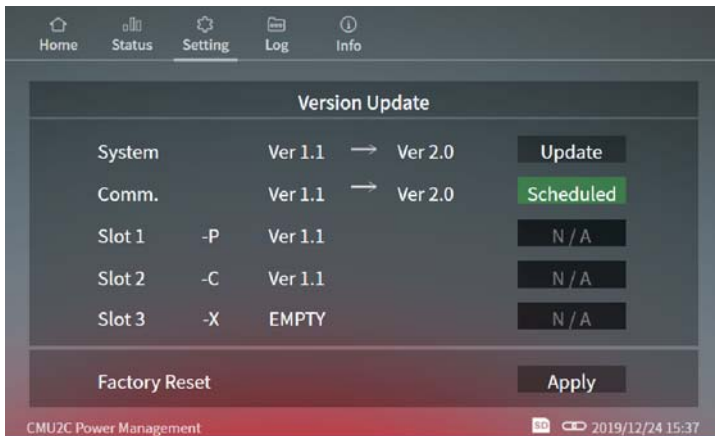

#### 5.1.4 Log

The CMU2 provides data log and event log for users to view operation status and diagnose problems that might arise.  
Note: Please insert a SD card to enable data log and event log.

#### 5.1.4.1 Data log

Data Log stores the measurement data at selected intervals and provides a full history database for users to extract and load. One page can display 8 data and there are 180 pages in total in the system. A maximum of 1440 data can be recorded on a day.

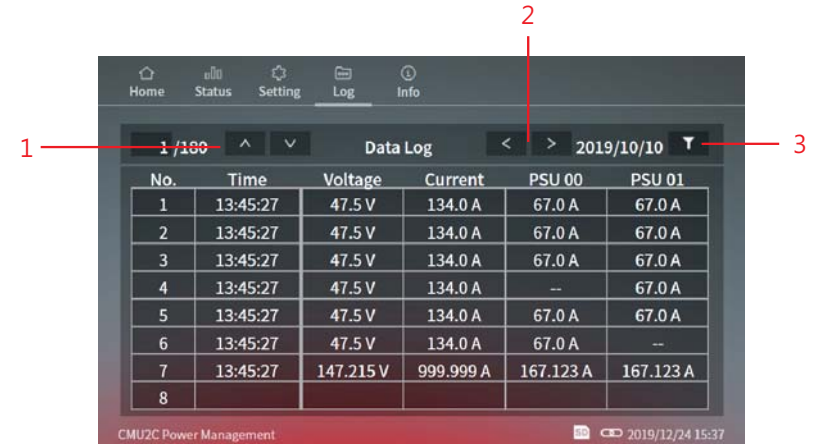



#### Data log page – options

The following functions are available in Data Log page:

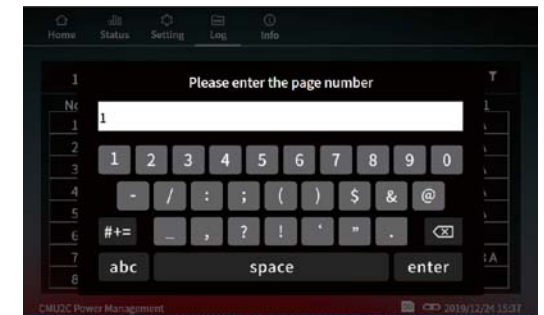
No.	Name	Description
1	Page selection	<p>1) 「^」 「v」 can be used to select pages, single tap to display the next or previous pages. (Tap 「^」 on the first page will jump to page 180 and vice versa)</p> <p>2) To jump to a certain page, you can tap <b>1/180</b> to use the keyboard.</p>



No.	Name	Description
2	Data selection 	「<」 「>」 can be used to select operation information that wants to view, including bus voltage, current in total or in single.
3	Data in certain time 	To jump to a certain date and time, you can tap the icon to use the scroll wheel. 



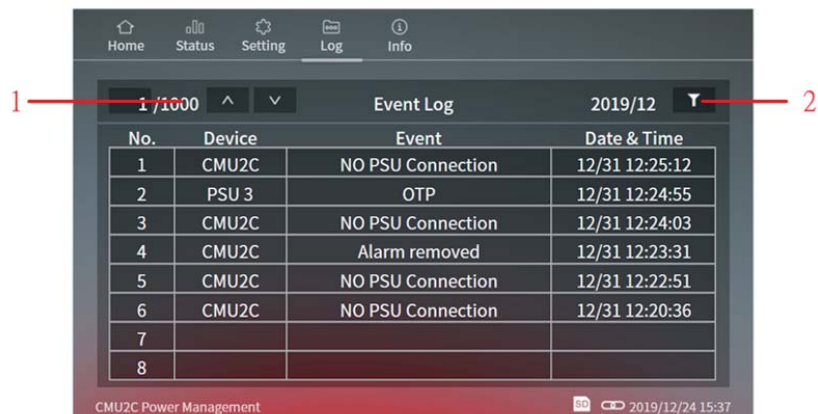

#### 5.1.4.2 Event log

Event Log stores information about all abnormal events that occur in the system. One page can display 8 data and there are 1000 pages in total in the system.

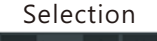

#### Event Log page – options

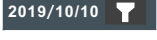
The following functions are available in Event Log page:

No.	Name	Description
1	Page Selection 	1) 「^」 「v」 can be used to select pages, single tap to display the next or previous pages. (Tap 「^」 on the first page will jump to page 1000 and vice versa) 2) To jump to a certain page, you can tap  1000 to use the keyboard. 
2	Data in Certain Time 	To jump to a certain date and time, you can tap the icon to use the scroll wheel. 

## 5.2 Web-based User Interface

### 5.2.1 System requirements

#### ◎System requirements

- 1.Windows 10
- 2.AMD or Intel Pentium 133MHz or better based computer
- 3.10/100 BASE-T Ethernet port
- 4.Google Chrome, Firefox or Microsoft Edge

### 5.2.2 Connection and IP setting

#### ◎Connection diagram

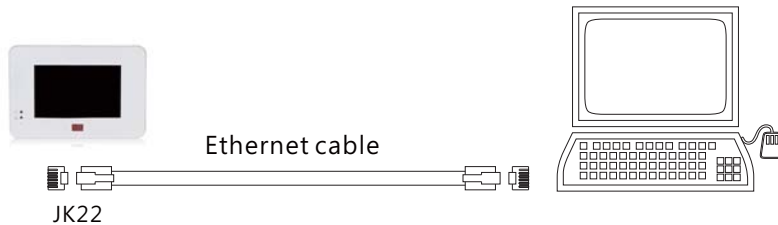

Before accessing to the built-in web page, please make sure that the CMU2 and the PC are set in the same domain. Please refer to IP setting for detail.

#### ※ Default IP address setting

Address	Default
IP address	169.254.1.1
Subnet mask	255.255.0.0
Default gateway	169.254.1.1

#### ◎IP setting

You can change IP address setting of the CMU2 to let your local network to identify the device or you also can change IP address setting of your PC to access to the CMU2. Please follow the instruction below to set IP address of your PC.

- ① Only connect the PC to the CMU2 and make sure there is no other devices connected to the PC.
- ② Click the "Network and Internet Connections" option. Then click the "Local Area Connection". Select "Internet Protocol (TCP/IP)", and then click the "Properties" button. If there are "Internet Protocol Version 4 (TCP/IPv4)" and "Internet Protocol Version 6(TCP/IPv6)" shown on the table, choose "Internet Protocol Version 4 (TCP/IPv4)".

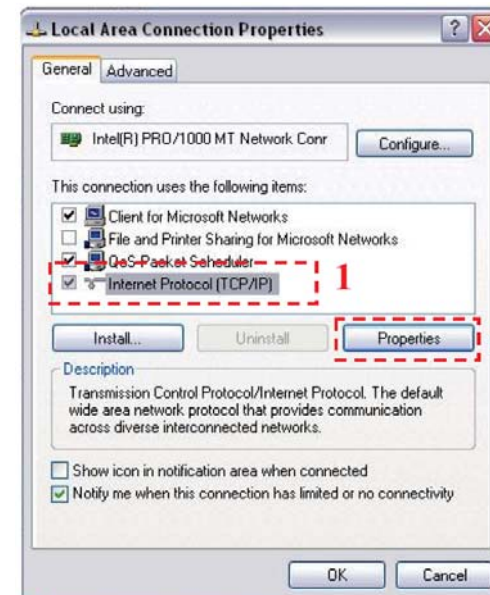

- ③ Click the "Use the following IP address" and then type addresses in "IP address", "Subnet mask" and "Default gateway" boxes, after that click the "OK" button. The IP address you set should be in the same domain as CMU2 but not the identical IP. Here is an example below for your reference.

Address	Default (for ex.)
IP address	169.254.1.2
Subnet mask	255.255.0.0
Default gateway	169.254.1.1

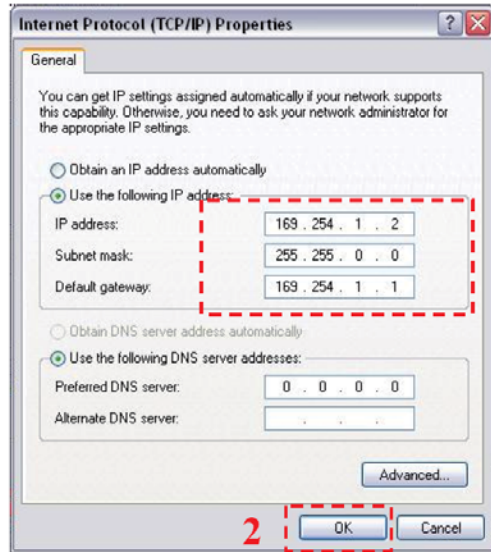

- ④ Check if it is working correctly by clicking the "Support" .  
If the addresses presented as you typed, it is successfully done. Then you can access the built-in web page.

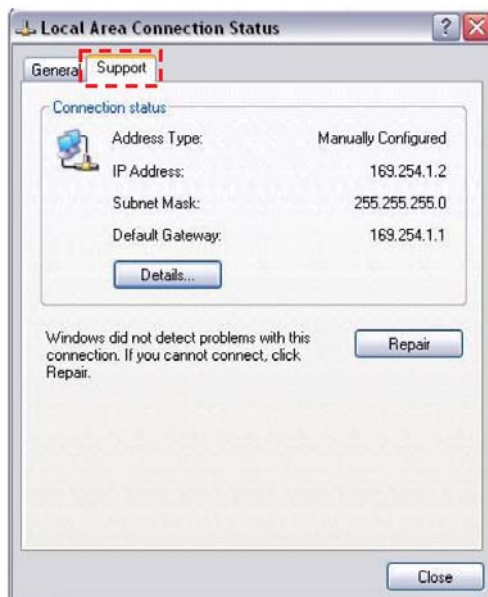

If the table shows below, it means that your RJ-45 cable is not connected properly or the IP address you set is incorrect.

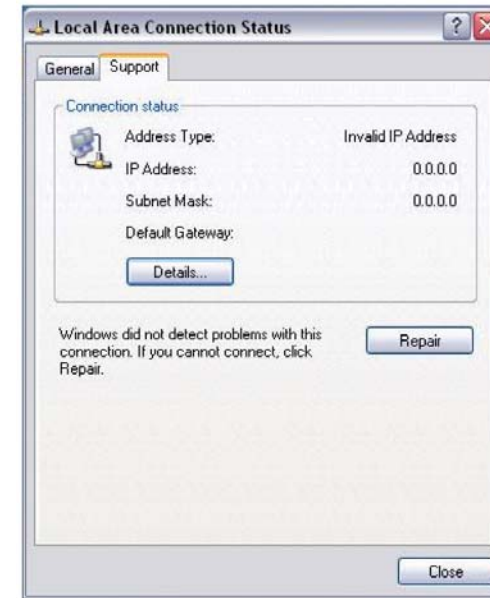

### 5.2.3 How to Open the Web Page

Connect your PC to the CMU2, then open a blank page and type the IP address of the CMU2 in the address bar. If you are not sure the IP address of the CMU2, refer to the touch panel interface. The route is "Setting" → "System" → "Network" . (Default IP: 169.254.1.1)

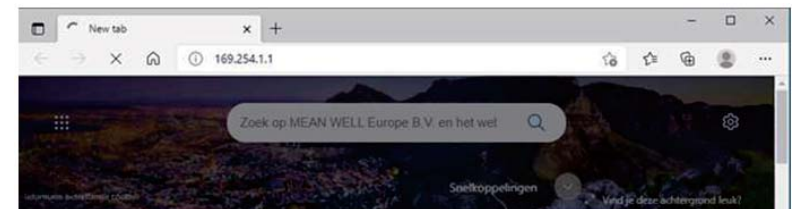

### 5.2.4 HOME

The HOME page of the built-in web displays output power, number of PSU connected, bus voltage, total current, information on firmware versions. Users can enter other pages by clicking the menu bar, located in the top-right corner.

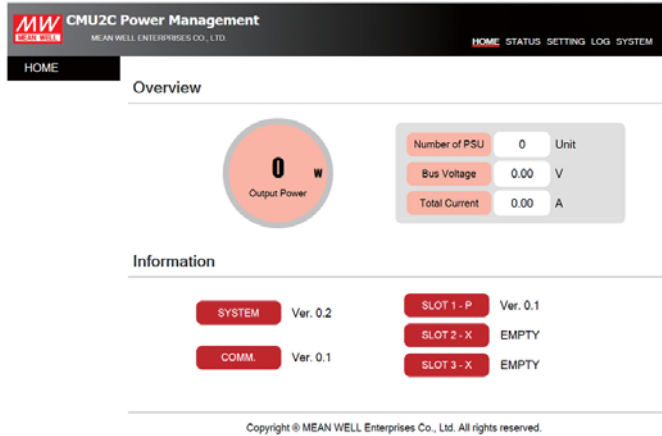

### 5.2.5 STATUS

STATUS page displays status of PSUs, digital I/O and relays.

#### 5.2.5.1 PSU Status

PSU Status page displays information of address number, power wattage, current, temperature, model name, serial number, firmware version, alarm and online status.

No.	Power	Current	Temp.	Model	S/N	Ver.	Alarm	Status
00	0 W	0.00 A	29.5 °C	DRP-3200-48	200715000004	R01.3	--	Running
01	239 W	4.00 A	30.5 °C	DRP-3200-48	200417000004	R01.3	--	Running
02	--	--	--	--	--	--	--	Disconnect
03	--	--	--	--	--	--	--	Disconnect
04	--	--	--	--	--	--	--	Disconnect
05	--	--	--	--	--	--	--	Disconnect
06	--	--	--	--	--	--	--	Disconnect
07	--	--	--	--	--	--	--	Disconnect
08	--	--	--	--	--	--	--	Disconnect

### 5.2.5.2 Digital/Relay

This page displays status of the digital input/ output and relays.

- **Digital Input/ Output**

Digital Input: There are 2 conditions, it displays green when logic high whereas it displays gray when logic low. It remains logic high when no signal connected due to hardware design.

Digital Output: There are 2 conditions, it displays green when the trigger condition is met whereas it displays gray when the trigger condition is not met.

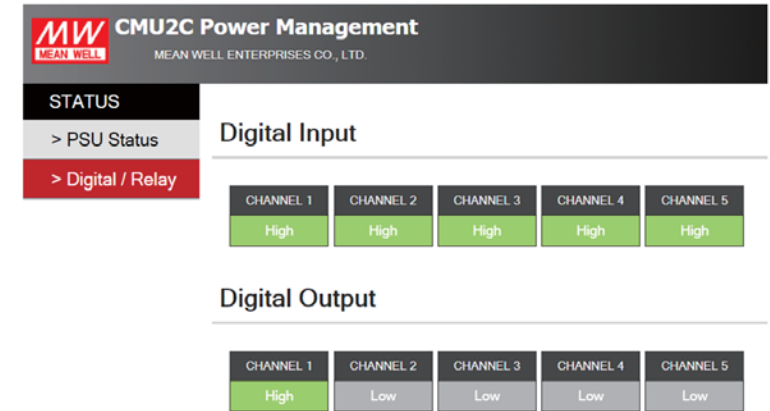

- **Relay**

Relay displays output state and setting parameters of the four programmable relays, including relay status, source, trigger and delay. If the trigger condition is met, it will display NO (Normal Open) in green; if the trigger condition is not met, it will display NC (Normal Close) in gray.

STATUS		Relay1			
> PSU Status		STATUS	SOURCE	TRIGGER	DELAY
> Digital / Relay		NO	DI CH1	High	Immed.

STATUS		Relay2			
		STATUS	SOURCE	TRIGGER	DELAY
		NC	DI CH2	Low	Immed.

STATUS		Relay3			
		STATUS	SOURCE	TRIGGER	DELAY
		NC	DI CH3	Low	Immed.

STATUS		Relay4			
		STATUS	SOURCE	TRIGGER	DELAY
		NC	Alarm	OLP	Immed.

There are up to 285 permutations according to different trigger conditions. Trigger selection is shown as below:

STATUS	SOURCE	TRIGGER	DELAY
NO(normal open) \ NC(normal close)	Alarm	Any \ OVP \ OLP \ Short \ OTP \ AC-Fail \ Fan Lock	Immed.(default) \ 1Sec \ 5Sec \ 10Sec \ 30Sec \ 1~10Min
	PSU	On \ Off	
	DI CH1-5	High \ Low	

## 5.2.6 SETTING

SETTING page provides setting of PSU on/off, output adjustment and digital I/O channels and relays.

Detailed information is described in the following sections.

### 5.2.6.1 PSU on/off

Users can turn all PSUs with 0 – 47 address on/off in the page. It is able to turn single or the whole PSUs on or off. Click **All on** or **All off** on the top right to turn on/off all online PSUs or to turn a certain PSU on/off in the red dotted rectangle.

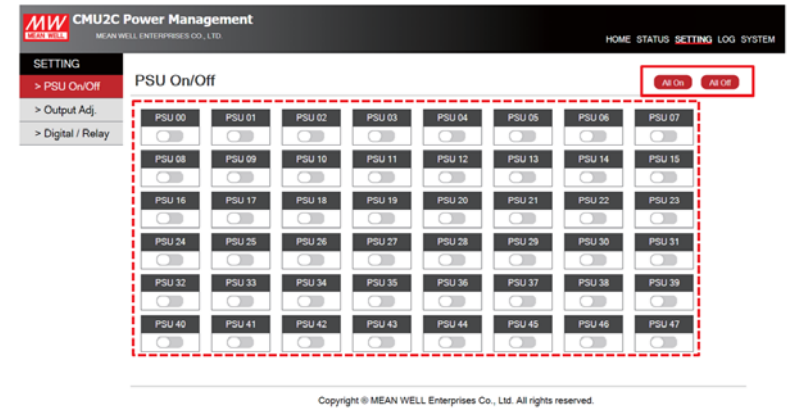

Note: You cannot turn on/off PSUs not online.

### 5.2.6.2 Output adj.

Output adj. page can be used to set output voltage and current and displays their adjustable range.

Click the red mark above to adjust output voltage. Click APPLY to set a desired value after adjustment.

Click the blue mark below to adjust output current. Click APPLY to set a desired value after adjustment.

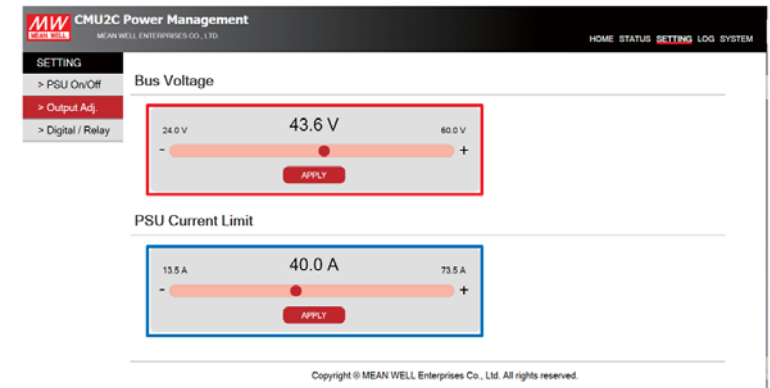

### 5.2.6.3 Digital/Relay

This page is used to set functions of the digital I/O channels and relays.

- **Digital Output**

Each digital output channel can flexibly set a source, a trigger definition, an action and a delay.

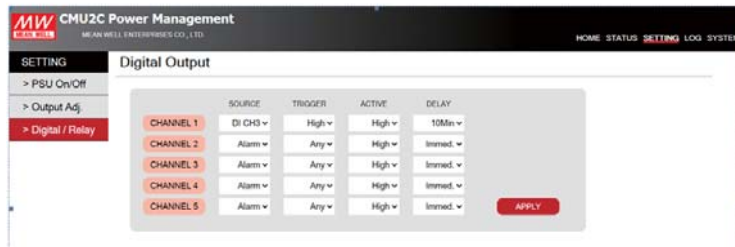

After setting, click **APPLY** to write your new parameters. Please refer to the table below for detailed triggering functions.

SOURCE	TRIGGER	ACTIVE	DELAY
Alarm (default)	Any (default), OVP, OLP, Short, OTP, AC-Fail, Fan Lock	High (default), Low	Immed.(default) · 1Sec · 5Sec · 10Sec · 30Sec · 1~10Min
PSU	On, Off		
DI CH1 - DI CH5	High, Low		

Source:

Alarm, PSU or digital input channels are available to be selected. After selection, the corresponding trigger conditions will appear. For instance: trigger definitions will move to relevant protection options for the rack powers when alarm is selected.

Trigger definitions:

- (1) Alarm: Trigger the output channel when one of the supplies meets alarm conditions, such as OVP, OLP, short circuit or any of the protections (default).
- (2) PSU: I. PSU ON: Trigger the output channel if one of the supplies is running  
II. PSU OFF: Trigger the output channel if one of the supplies is remote off or in alarm conditions.  
III. PSU OFF: Trigger the output channel if all of the supplies are disconnect.
- (3) DI CH1 – CH5(digital input channels): Trigger the output channel according to condition of the selected input channel.

Active:

Determine the logic level when outputting. High (high level): 5V; Low (low level): 0V.

Delay:

Determine how long to delay before outputting when the trigger condition is met. There are imminently (default), 1Sec ... 10Min available.

● **Relay**

Relay is used to set four programmable relays to realize alarm functions you need. In addition, the relays also can work with digital inputs to do further applications.

**Relay**



Each relay can flexibly set a source, a trigger definition and a delay. After setting, click **APPLY** to write your new parameters. Please refer to the table below for detailed triggering functions.

SOURCE	TRIGGER	DELAY
Alarm (default)	Any (default), OVP, OLP, Short, OTP, AC-Fail, Fan Lock	Immed.(default) · 1Sec · 5Sec · 10Sec · 30Sec · 1~10Min
PSU	On, Off	
DI CH1 - DI CH5	High, Low	

Source:

Alarm, PSU or digital input channels are available to be selected. After selection, the corresponding trigger conditions will appear. For instance: trigger definitions will move to relevant protection options for the rack powers when alarm is selected.

Trigger definition:

- (1) Alarm: Trigger the output channel when one of the supplies meets alarm conditions, such as OVP, OLP, short circuit or any of the protections (default).
- (2) PSU: I. PSU ON: Trigger the relay if one of the supplies is running  
II. PSU OFF: Trigger the relay if one of the supplies is remote off or in alarm conditions.  
III. PSU OFF: Trigger the relay if all of the supplies are disconnect.
- (3) DI CH1 – CH5 (digital input channels): Trigger the relay according to condition of the selected input channel.

Delay:

Determine how long to delay before triggering the relay when the trigger condition is met. There are imminently (default), 1Sec ... 10Min available.

### 5.2.7 LOG

LOG page provides data log and event log for users to view operation status and diagnose problems that might arise.

Note: Please insert a SD card to enable data log and event log.

#### 5.2.7.1 Data Log

Data Log stores the measurement data at selected intervals and provides a full history database for users to extract and download. Date displays with a red dot if there is recorded data. For example: 14; If there is no data recorded, then the date will be shown without red dot. The data is readable in .CSV format, click the date you want to view to download it.

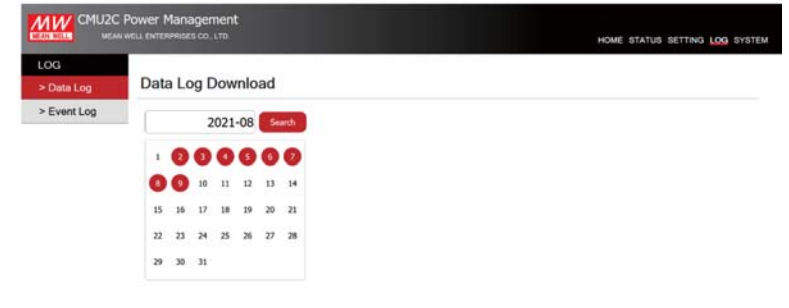

Note: FireFox does not support a date picker function, users has to enter date manually.

#### Data Log information

Time	Bus Volta	Total Curri	PSU 0	PSU 1	PSU 2	PSU 3	PSU 4	PSU 5	PSU 6	PSU 7	PSU 8	PSU 9	PSU 10	F
2021/8/3 08:32 48.26V	141.25A	0.00A	0.00A	0.00A	0.00A	0.00A	0.00A	0.00A	0.00A	0.00A	0.00A	0.00A	0.00A	0
2021/8/3 08:33 0.00V	0.00A	0.00A	0.00A	0.00A	0.00A	0.00A	0.00A	0.00A	0.00A	0.00A	0.00A	0.00A	0.00A	0
2021/8/3 08:34 0.00V	0.00A	0.00A	0.00A	0.00A	0.00A	0.00A	0.00A	0.00A	0.00A	0.00A	0.00A	0.00A	0.00A	0
2021/8/3 08:35 0.00V	0.00A	0.00A	0.00A	0.00A	0.00A	0.00A	0.00A	0.00A	0.00A	0.00A	0.00A	0.00A	0.00A	0
2021/8/3 08:36 48.64V	389.50A	9.75A	10.00A	10.00A	9.75A	9.75A	9.75A	9.75A	9.75A	9.50A	9.75A	9.75A	9.75A	9
2021/8/3 08:37 48.31V	400.00A	70.75A	70.50A	70.75A	70.75A	0.00A	0.00A	0.00A	0.00A	9.50A	0.00A	0.00A	0.00A	7
2021/8/3 08:38 0.00V	0.00A	0.00A	0.00A	0.00A	0.00A	0.00A	0.00A	0.00A	0.00A	0.00A	0.00A	0.00A	0.00A	0
2021/8/3 08:39 0.00V	96.75A	0.00A	0.00A	0.00A	0.00A	0.00A	0.00A	0.00A	0.00A	0.00A	0.00A	0.00A	0.00A	0
2021/8/3 08:40 48.64V	75.75A	0.00A	0.00A	0.00A	0.00A	0.00A	0.00A	0.00A	0.00A	0.00A	0.00A	0.00A	0.00A	0
2021/8/3 08:41 0.00V	155.75A	0.00A	0.00A	0.00A	0.00A	0.00A	0.00A	0.00A	0.00A	0.00A	0.00A	0.00A	0.00A	0
2021/8/3 08:42 0.00V	0.00A	0.00A	0.00A	0.00A	0.00A	0.00A	0.00A	0.00A	0.00A	0.00A	0.00A	0.00A	0.00A	0
2021/8/3 08:43 0.00V	0.00A	0.00A	0.00A	0.00A	0.00A	0.00A	0.00A	0.00A	0.00A	0.00A	0.00A	0.00A	0.00A	0
2021/8/3 08:44 0.00V	0.00A	0.00A	0.00A	0.00A	0.00A	0.00A	0.00A	0.00A	0.00A	0.00A	0.00A	0.00A	0.00A	0
2021/8/3 08:45 48.48V	126.00A	0.00A	0.00A	0.00A	0.00A	0.00A	0.00A	0.00A	0.00A	0.00A	0.00A	9.75A	9.75A	9
2021/8/3 08:46 48.64V	390.50A	10.00A	10.00A	9.75A	10.00A	9.75A	9.75A	9.50A	9.75A	9.75A	9.75A	9.75A	9.75A	9
2021/8/3 08:47 0.00V	0.00A	0.00A	0.00A	0.00A	0.00A	0.00A	0.00A	0.00A	0.00A	0.00A	0.00A	0.00A	0.00A	0
2021/8/3 08:48 0.00V	82.75A	0.00A	0.00A	0.00A	0.00A	0.00A	0.00A	0.00A	0.00A	0.00A	0.00A	13.25A	15.00A	1
2021/8/3 08:49 48.83V	49.50A	10.00A	9.75A	9.75A	0.00A	0.00A	0.00A	0.00A	0.00A	0.00A	0.00A	0.00A	0.00A	0
2021/8/3 08:40 48.60V	464.00A	74.75A	74.75A	74.50A	74.75A	75.00A	74.75A	74.75A	75.00A	74.75A	74.75A	74.75A	74.75A	7

#### 5.2.7.2 Event Log

Event Log stores information about all abnormal events that occur in the system. Month displays with a red dot if there is recorded data. For example: 8; If there is no data recorded, then the month will be shown without red dot. The data is readable in .CSV format, click the month you want to view to download it.



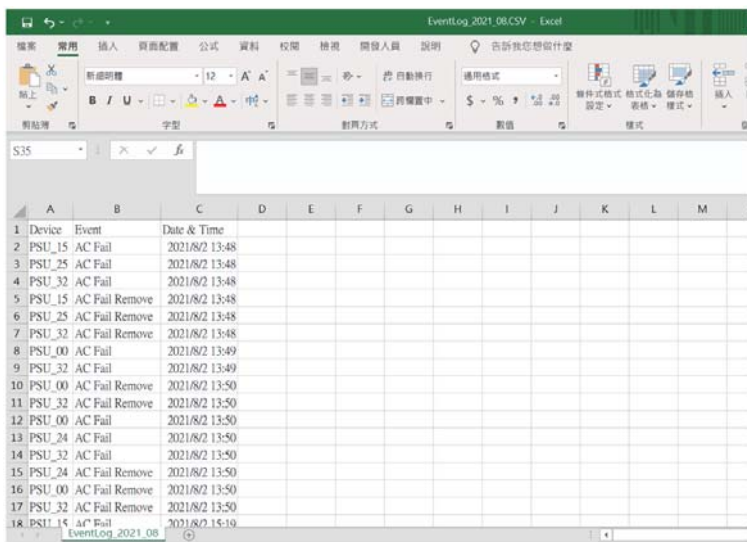
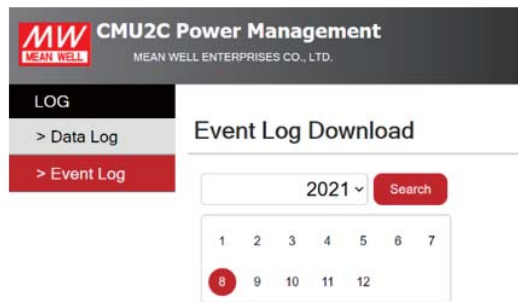

## 5.2.8 SYSTEM

SYSTEM page provides setting of Network, Notice, Security and Data/Event Log.

### 5.2.8.1 Network

Network page provides IP address setting. The new settings will take effect after power recycling.

IP address	Default
IP address	169.254.1.1
Subnet mask	255.255.0.0
Default gateway	169.254.1.1

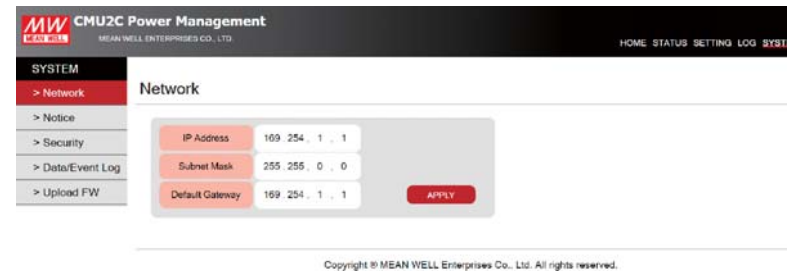

### 5.2.8.2 Notice

The CMU2 can send emails to notify users when the system power is abnormal so that the issue can be investigated.

#### Mail Server

Server IP: Set the IP address of SMTP server

User Name: Edit your user name (max 25 words)

Password: Edit your password for the SMTP (max 25 words)

#### Notice

Send to: Up to five emails can be set (max 25 words each)



#### Notice



Note:

- (1) Up to 5 emails can be sent at a time, the next email will be sent after one has been sent.
- (2) The maximum content of a single mail is 3000 bytes.
- (3) Retransmission mechanism for transmission failure is 3 times, with 10min time interval.
- (4) Email sends when there is any new event log that occurs.

### Email sample:



### 5.2.8.3 Security

You can change your password in this page, with max 15 words. Please input the old and new passwords and then tap **APPLY** to change the password. The default password: CMU2C.



### 5.2.8.4 Data/Event Log

This page provides relevant settings for data log and event log, including data log interval, clear data log and clear event log.

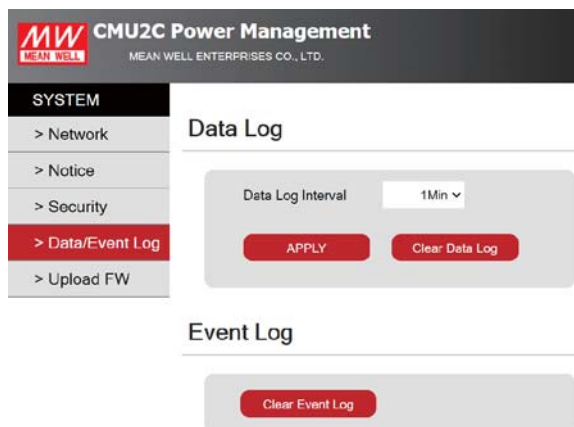

- **Data Log**

Click the box to select a certain interval to record operation data of the rack powers.

There are 9 options: 1Min, 2Min, 5 Min, 10 Min, 20 Min, 30 Min, 40 Min, 50Min, 1Hr. (Default: 1Min)

Clicking **Clear Data Log** can remove data log recorded.



- **Event Log**

Clicking **Clear Data Log** can remove event log recorded.



### 5.2.7 LOG

The LOG page provides data log and event log functions, allowing users to confirm the usage of system power.

Note: Please install SD card to enable log function.

## 5.3 MODBUS TCP Interface

The device supports Modbus TCP communication protocol. Clients are able to read and write parameters of the CMU2C (server) through the protocol, including remote ON/OFF, output voltage/current setting, PSU internal temperature reading, etc. During data transfer, please follow the principle of first sending the Hi byte and then the Lo byte.

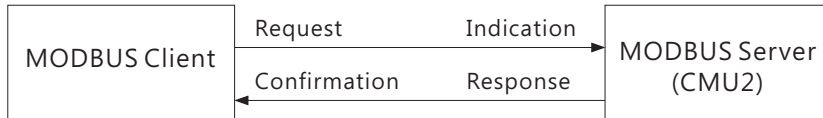

All Modbus/TCP Message Frames are sent via TCP on registered port 502. For the IP Address, please refer to Network page of the CMU2

### 5.3.1 Communication Timing

- Min. request period (Controller(client) to CMU2(Server)): 20mSec °
- Max. response time (CMU2(Server) to Controller(client)): 5mSec °
- Min. packet margin time (Controller(client) to CMU2(Server)): 5mSec °

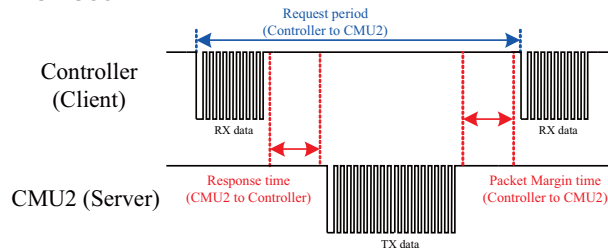

### 5.3.2 Modbus Frame Encapsulation

Modbus TCP message framing consists of MBAP Header, Function Code and Data.

MBAP Header	Function Code	Data
7 bytes	1 byte	N bytes

**MBAP Header (7bytes)** : It is a dedicated header that is used on TCP/IP to identify the MODBUS Application Data Unit.

**Function code (1byte)** : The function codes are used to tell the server what kind of action to perform.

**Data (N bytes)** : For data exchange, contents and data length are dependent on different function codes.

### 5.3.3 MBAP Header Definition

MBAP Header consists of the following parts:

Fields	Length	Description
Transaction Identifier	2 bytes	Identification of a MODBUS Request / Response transaction. Initialized by the client and recopied by the server from the received request.
Protocol Identifier	2 bytes	0 = Modbus TCP, meaning a PDU communication protocol.
Length	2 bytes	Number of following bytes, including Unit Identifier, Function code and Data Fields.
Unit Identifier	1 byte	Identification of a remote slave connected on a serial line or on other buses. Initialized by the client and recopied by the server from the received request (Not for the purpose of Modbus TCP to RTU gateway)

### 5.3.4 Function Code Description

The main purpose of the function codes is to tell the server what kind of action to perform. For example: Function code 03 will query the server to read holding registers and respond with their contents.

Code	Function
0x03	Read Holding Register
0x04	Read Input Register
0x06	Preset Single Register
0x10	Write Multiple Register
0x64	Read Array Log

### 5.3.5 Data Field and Command Lists

Data field provides additional information by the server to complete the action specified by the function code in the client's request. The data field typically includes register addresses, count values, and written data. There are several forms according to the function codes.

FC = 03

Request:

Starting Address	Quantity of Registers
2 Bytes	2 Bytes

Response:

Byte Count	Register Value
1 Byte	N* x 2 Bytes

N\* = Quantity of Registers

FC = 04

Request:

Starting Address	Quantity of Input Registers
2 Bytes	2 Bytes

Response:

Byte Count	Input Register
1 Byte	N* x 2 Bytes

N\* = Quantity of Registers

FC = 06

Request:

Register Address	Register Value
2 Bytes	2 Bytes

Response:

Starting Address	Register Value
2 Bytes	2 Bytes

FC = 10

Request:

Starting Address	Quantity of Registers	Byte Count	Registers Value
2 Bytes	2 Bytes	1 Byte	N* x 2 Bytes

N\* = Quantity of Registers

Response:

Starting Address	Quantity of Registers	Byte Count	Registers Value
2 Bytes	2 Bytes	1 Byte	N* x 2 Bytes

FC = 64

Request:

Starting Address	Quantity of Input Registers
2 Bytes	2 Bytes

Response:

Byte Count	Input Register
1 Byte	N* x 2 Bytes

System and PSU Settings (address range:0x0000~0x0038):

Register Addresses	Command Name	Supported Function Codes	# of data Bytes	Description
0x0000	OPERATION (All)	0x06、0x10	2	Turn all PSUs on/off. ON: 0x0001 OFF: 0x0000
0x0001	OPERATION (PSU#0~15)	0x03、0x06、0x10	2	Turn PSU0 – PSU15 on/off. ON: 0x0001 OFF: 0x0000
0x0002	OPERATION (PSU#16~31)	0x03、0x06、0x10	2	Turn PSU16 – PSU31 on/off. ON: 0x0001 OFF: 0x0000
0x0003	OPERATION (PSU#32~47)	0x03、0x06、0x10	2	Turn PSU32 – PSU47 on/off. ON: 0x0001 OFF: 0x0000

Register Addresses	Command Name	Supported Function Codes	# of data Bytes	Description
0x0010	VOUT_SET (All)	0x03、0x06、0x10	2	Set output voltage of the all PSUs (format: value, F=0.1)
0x0011	IOUT_SET (All)	0x03、0x06、0x10	2	Set output current of the all PSUs (format: value, F=0.1)
0x0030	Relay1	0x03、0x06、0x10	2	Relay1 setting
0x0031	Relay2	0x03、0x06、0x10	2	Relay2 setting
0x0032	Relay3	0x03、0x06、0x10	2	Relay3 setting
0x0033	Relay4	0x03、0x06、0x10	2	Relay4 setting
0x0034	Digital Output 1 (DOUT #1)	0x03、0x06、0x10	2	Digital output 1 setting
0x0035	Digital Output 2 (DOUT #2)	0x03、0x06、0x10	2	Digital output 2 setting
0x0036	Digital Output 3 (DOUT #3)	0x03、0x06、0x10	2	Digital output 3 setting
0x0037	Digital Output 4 (DOUT #4)	0x03、0x06、0x10	2	Digital output 4 setting
0x0038	Digital Output 5 (DOUT #5)	0x03、0x06、0x10	2	Digital output 5 setting

Status Reading of CMU2 Relay and Digital IO (address range:0x0100~0x0101):

Register Addresses	Command Name	Supported Function Codes	# of data Bytes	Description
0x0100	Relay Status	0x03	2	Status reading of all relays
0x0101	Digital IO Status	0x03	2	Status reading of all digital inputs and outputs

Status Reading of PSU (PSU#0 - 47) (address range:0x0200~0x0229):

Register Addresses	Command Name	Supported Function Codes	# of data Bytes	Description
0x0200 +0x30*N	FAULT_STATUS	0x03	2	Read fault status of a single PSU
0x0201 +0x30*N	READ_VOUT	0x04	2	Read output voltage of a single PSU
0x0202 +0x30*N	READ_IOUT	0x04	2	Read output current of a single PSU
0x0203 +0x30*N	READ_TEMPERATURE_1	0x04	2	Read internal temperature of a single PSU
0x0204 +0x30*N	READ_FAN_SPEED_1	0x04	2	Read fan speed of the fan 1 of a single PSU
0x0205 +0x30*N	READ_FAN_SPEED_2	0x04	2	Read fan speed of the fan 2 of a single PSU
0x0210+0x30*N 0x0212+0x30*N	MFR_ID_B0B5	0x03	6	Read manufacturer's name of a single PSU
0x0213+0x30*N 0x0215+0x30*N	MFR_ID_B6B11	0x03	6	Read manufacturer's name of a single PSU
0x0216+0x30*N 0x0218+0x30*N	MFR_MODEL_B0B5	0x03	6	Read manufacturer's model name of a single PSU
0x0219+0x30*N 0x021B+0x2F*N	MFR_MODEL_B6B11	0x03	6	Read manufacturer's model name of a single PSU
0x021C+0x30*N 0x021E+0x30*N	MFR_REVISION_B0B5	0x03	6	Read firmware revision of a single PSU
0x021F+0x30*N 0x0220+0x30*N	MFR_LOCATION_B0B2	0x03	4	Read manufacturer's factory location of a single PSU
0x0221+0x30*N 0x0223+0x30*N	MFR_DATE_B0B5	0x03	6	Read manufacture date of a single PSU
0x0224+0x30*N 0x0226+0x30*N	MFR_SERIAL_B0B5	0x03	6	Read product serial number of a single PSU
0x0227+0x30*N 0x0229+0x30*N	MFR_SERIAL_B6B11	0x03	6	Read product serial number of a single PSU

※ N means PSU number, range: 0 – 47, 48 units in total.

※ Maximum register quantity for a single PSU is 48.

Status Reading of Event Log (address range:0x6000~0x07F3F):

Register Addresses	Command Name	Supported Function Codes	# of data Bytes	Description
0x6000	Event log #1	0x64	62	Read Event log #1
~	~	~	~	~
0x7F3F	Event log #8000	0x64	62	Read Event log #8000

※ N means No. of Event log, range: 0-7999, 8000 data in total

OPERATION (PSU#0~15/ PSU#16~31/ PSU#32~47)

(0x0001~0x0003) on/off Setting:

The tables below indicate data position for each PSU. When the bit of a PSU is "0", meaning the PSU is off; "1" means the PSU is on. For example: data for PSU#0~15 is 0x0001, meaning PSU#0 is on and the rest of PSU#1 - #15 are off.

PSU#0~15

	Bit7	Bit6	Bit5	Bit4	Bit3	Bit2	Bit1	Bit0
High byte	PSU#15	PSU#14	PSU#13	PSU#12	PSU#11	PSU#10	PSU#9	PSU#8
Low byte	PSU#7	PSU#6	PSU#5	PSU#4	PSU#3	PSU#2	PSU#1	PSU#0

PSU#16~31

	Bit7	Bit6	Bit5	Bit4	Bit3	Bit2	Bit1	Bit0
High byte	PSU#31	PSU#30	PSU#29	PSU#28	PSU#27	PSU#26	PSU#25	PSU#24
Low byte	PSU#23	PSU#22	PSU#21	PSU#20	PSU#19	PSU#18	PSU#17	PSU#16

PSU#32~47

	Bit7	Bit6	Bit5	Bit4	Bit3	Bit2	Bit1	Bit0
High byte	PSU#47	PSU#46	PSU#45	PSU#44	PSU#43	PSU#42	PSU#41	PSU#40
Low byte	PSU#39	PSU#38	PSU#37	PSU#36	PSU#35	PSU#34	PSU#33	PSU#32

Relay1~ Relay4(0x0030 - 0x0033) Setting:

	Bit7	Bit6	Bit5	Bit4	Bit3	Bit2	Bit1	Bit0
High byte	---	---	---	---	Source			
Low byte	Trigger				Delay			

Low byte:

Bit 0 - 3 Delay

Please refer to the table below for detailed parameter setting.

Bit 4 - 7 Trigger

Please refer to the table below for detailed parameter setting.

High byte:

Bit 0 - 3 Source

Please refer to the table below for detailed parameter setting.

Source	Trigger	Delay
0: Alarm	0: Any 1: OVP 2: OLP 3: Short 4: OTP 5: AC-Fail 6: Fan Lock	0: Immed. 1: 1 Sec 2: 5 Sec 3: 10 Sec 4: 30 Sec 5: 1 Min 6: 2 Min
1: PSU	7: On 8: Off	7: 3 Min 8: 4 Min
2: DI CH1	9: High 10: Low	9: 5 Min
3: DI CH2		10: 6 Min
4: DI CH3		11: 7 Min
5: DI CH4		12: 8 Min
6: DI CH5		13: 9 Min
		14: 10 Min

Digital Output 1~5(0x0030~0x0033) Setting:

	Bit7	Bit6	Bit5	Bit4	Bit3	Bit2	Bit1	Bit0
High byte	Source				Trigger			
Low byte	Action				Delay			

Low byte:

Bit 0 - 3 Delay

Please refer to the table below for detailed parameter setting.

Bit 4 - 7 Action

Please refer to the table below for detailed parameter setting.

High byte:

Bit 0 - 3 **Trigger**

Please refer to the table below for detailed parameter setting.

Bit 4 - 7 **Source**

Please refer to the table below for detailed parameter setting.

Source	Trigger	Action	Delay
0: Alarm	0: Any	9: High 10: Low	0: Immed.
	1: OVP		1: 1 Sec
	2: OLP		2: 5 Sec
	3: Short		3: 10 Sec
	4: OTP		4: 30 Sec
	5: AC-Fail		5: 1 Min
	6: Fan Lock		6: 2 Min
1: PSU	7: On		7: 3 Min
	8: Off		8: 4 Min
2: DI CH1	9: High 10: Low		9: 5 Min
3: DI CH2		10: 6 Min	
4: DI CH3		11: 7 Min	
5: DI CH4		12: 8 Min	
6: DI CH5		13: 9 Min	
		14: 10 Min	

Relay Status(0x0100) Definition:

	Bit7	Bit6	Bit5	Bit4	Bit3	Bit2	Bit1	Bit0
Low byte	---	---	---	---	Relay4	Relay3	Relay2	Relay1

Bit 0 **Relay 1** : Relay 1 status

- 0 = Relay OPEN
- 1 = Relay SHORT

.....

Bit 4 **Relay 4** : Relay 4 status

- 0 = Relay OPEN
- 1 = Relay SHORT

Digital I/O Status (0x0101) Definition:

	Bit7	Bit6	Bit5	Bit4	Bit3	Bit2	Bit1	Bit0
High byte	---	---	---	Di5	Di4	Di3	Di2	Di1
Low byte	---	---	---	DO5	Do4	Do3	Do2	Do1

Low byte:

Bit 0 **D01** : Digital Output 1 status

- 0 = LOW
- 1 = High

.....

Bit 4 **D04** : Digital Output 4 status

- 0 = LOW
- 1 = High

High byte:

Bit 0 **DI1** : Digital Input 1 status

- 0 = LOW
- 1 = High

.....

Bit 4 **DI5** : Digital Input 5 status

- 0 = LOW
- 1 = High

FAULT\_STATUS(0x0200 +0x30\*N) Definition:

	Bit7	Bit6	Bit5	Bit4	Bit3	Bit2	Bit1	Bit0
Low byte	HI_TEMP	OP_OFF	AC_FAIL	SHORT	OLP	OVP	OTP	FAN_FAIL

Low byte:

Bit 0 **FAN\_FAIL** : Fan locked flag

- 0 = Fan working normally
- 1 = Fan locked

Bit 1 **OTP** : Over-temperature protection

- 0 = Internal temperature normal
- 1 = Internal temperature abnormal

Bit 2 **OVP** : Over-voltage protection

- 0 = DC voltage normal
- 1 = DC over voltage protected

- Bit 3 **OLP : Over-load protection**  
0 = DC current normal  
1 = DC over current protected
- Bit 4 **SHORT : Short-circuit protection**  
0 = Shorted circuit do not exist  
1 = Shorted circuit protected
- Bit 5 **AC\_FAIL : AC abnormal flag**  
0 = AC range abnormal  
1 = AC range abnormal
- Bit 6 **OP\_OFF : DC status**  
0 = DC turned on  
1 = DC turned off
- Bit 7 **HI\_TEMP : Internal high temperature alarm**  
0 = Internal high temperature alarm  
1 = Internal temperature high

MFR\_ID\_B0B5(0x0210+0x30\*N ~0x0212+0x30\*N) is the first 6 codes of the manufacture's name (ASCII); MFR\_ID\_B6B11(0x0213+0x30\*N ~0x0215+0x30\*N) is the last 6 codes of the manufacturer's name (ASCII)

EX: manufacturer's name is MEANWELL MFR\_ID\_B0B5 is MEANWE;  
MFR\_ID\_B6B11 is LL

MFR_ID_B0B5					
Byte0	Byte1	Byte2	Byte3	Byte4	Byte5
0x4D	0x45	0x41	0x4E	0x57	0x45

MFR_ID_B6B11					
Byte0	Byte1	Byte2	Byte3	Byte4	Byte5
0x4C	0x4C	0x20	0x20	0x20	0x20

MFR\_MODEL\_B0B5(x0216+0x30\*N ~0x021B+0x2F\*N) is the first 6 codes of the manufacturer's model name (ASCII);  
MFR\_MODEL\_B6B11 is the last 6 codes of the manufacturer's model name (ASCII)  
EX: Model name is DRP-3200-24 MFR\_MODEL\_B0B5 is DRP-32 ;  
MFR\_MODEL\_B6B11 is 00-24

MFR_MODEL_B0B5					
Byte0	Byte1	Byte2	Byte3	Byte4	Byte5
0x50	0x48	0x50	0x2D	0x33	0x35

MFR_MODEL_B6B11					
Byte6	Byte7	Byte8	Byte9	Byte10	Byte11
0x30	0x30	0x2D	0x32	0x34	0x20

MFR\_REVISION\_B0B5 (0x021C+0x30\*N ~0x021E+0x30\*N) is the firmware revision (hexadecimal). A range of 0x00 (R00.0) ~ 0xFE (R25.4) represents the firmware version of a MCU; 0xFF represents on MCU existed  
EX: The supply has two MCUs. The firmware version of the MCU number1 is version R25.4(0xFE), the MCU number 2 is version R10.5 (0x69)

Byte0	Byte1	Byte2	Byte3	Byte4	Byte5
0xFE	0x69	0xFF	0xFF	0xFF	0xFF

MFR\_DATE\_B0B5 is manufacture date (ASCII)  
EX: MFR\_DATE\_B0B5 is 180101, meaning 2018/01/01

Byte0	Byte1	Byte2	Byte3	Byte4	Byte5
0x31	0x38	0x30	0x31	0x30	0x31

MFR\_SERIAL\_B0B5(0x0224+0x30\*N ~0x0226+0x30\*N) and MFR\_SERIAL\_B6B11(0x0227+0x30\*N ~0x0229+0x30\*N) are defined as manufacture date and manufacture serial number (ASCII)

EX: The first unit manufactured on 2018/01/01 MFR\_SERIAL\_B0B5: 180101;  
MFR\_SERIAL\_B6B11 is 000001

Byte0	Byte1	Byte2	Byte3	Byte4	Byte5
0x31	0x38	0x30	0x31	0x30	0x31

Byte6	Byte7	Byte8	Byte9	Byte10	Byte11
0x30	0x30	0x30	0x30	0x30	0x31

Event Log(0x6000~0x07F3F) Data structure Definition  
Event data store as ASCII strings. Maximum bytes for a No. resistor is 62 bytes, data length is dependent on its actual content. If no data that exists, it will display 0x00.

Byte 0	-----						ByteN
Max10 Bytes	1Byte	Max20 Bytes	1Byte	Max10 Bytes	1Byte	Max 18 Bytes	1Byte
Device	,	Event	,	date	space	time	\n

- ※ N means data length, maximum length is 27 bytes.
- ※ Byte 0 sends first



Device (Max 10 Bytes)	Event (Max 20 Bytes)	Date (Max 10 Bytes)	Time (Max 8 Bytes)
System	1 · EEPROM Error 2 · EEPROM Error Remove 3 · Model Error 4 · Model Error Remove 5 · Comm. Error 6 · Comm. Err Remove	20YY/MM/DD	HH:MM:SS
PSU_00 ~ PSU_47	1 · OVP 2 · OVP Remove 3 · OLP 4 · OLP Remove 5 · Short 6 · Short Remove 7 · OTP 8 · OTP Remove 9 · AC Fail 10 · AC Fail Remove 11 · FAN Lock 12 · FAN Lock Remove		

Please refer to 5.11.3.7.3 for an event log query.

### 5.3.6 Communication Examples

The following provides examples of request and response for each function code of the Modbus TCP protocol.

#### 5.3.6.1 Read Holding Registers (FC=03)

The request message specifies the starting register and quantity of registers to be read.

For example: Client requests the content of analog output holding registers 0x021C – 0x021E (MFR\_REVISION\_BOB5) from the server

Request:

0x00020000000601	0x03	0x021C	0x0003
------------------	------	--------	--------

0x00020000000601: MBAP Header

0x03: Function code 3 (Read Analog Output Holding Registers)

0x021C: The Data Address of the first register requested.

0x0003: The total number of registers requested (Read 3 registers from 0x021C to 0x021E)

Response:

0x00020000000901	0x03	0x06	0x0A0A0AFFFFFF
------------------	------	------	----------------

0x00020000000901: MBAP Header

0x03: Function code 3 (Read Analog Output Holding Registers)

0x06: The number of data bytes to follow (6 bytes)

0x0A 0A 0A FF FF FF: means that the firmware version of the MCU number1 is R01.0, R01.0 for the MCU number 2 and R01.0 for the MCU number 3.

#### 5.3.6.2 Read Input Register (FC=04)

The request message specifies the starting register and quantity of registers to be read.

For example: Client requests the content of analog input register 0x0201 (READ\_VOUT from the PSU with address 0) from the server

Request:

0x00020000000601	0x04	0x0201	0x0001
------------------	------	--------	--------

0x00020000000601: MBAP Header

0x04: Function code 4 (Read Analog Input Registers)

0x0201: The Data Address of the first register requested

0x0001: The total number of registers requested (Read only 1 registers from 0x0201)

Response:

0x00020000000501	0x04	0x02	0x157C
------------------	------	------	--------

0x00020000000501: MBAP Header

0x04: Function code 4 (Read Analog Input Register)

0x02: The number of data bytes to follow (2 bytes)

0x157C: The contents of register: 0x0201.  $157C_{16} = 5500_{10} = 55.00V$

#### 5.3.6.3 Write Single Register (FC=06)

The request message specifies the register reference to be written.

For example: Client writes all PSU ON to analog output holding register of 0x0000 (OPERATION)

Request:

0x00020000000601	0x06	0x0000	0x0001
------------------	------	--------	--------

0x00020000000601: MBAP Header  
 0x06: Function code 6 (Preset Single Register)  
 0x0000: The Data Address of the register  
 0x0001: The value to write

Response:

The normal response is an echo of the query, returned after the register contents have been written.

#### 5.3.6.4 Write Multiple Register (FC=10)

The request message specifies the multi-register references to be written.

For example: Client writes PSU#0-15 ON and the rest of PSU#16-47 OFF to analog output holding register of 0x0001~0x0003 (OPERATION(PSU#0~47))

Request:

0x00020000000D01	0x10	0x0001	0x0003	0x03	0xFFFF	0x0000	0x0000
------------------	------	--------	--------	------	--------	--------	--------

0x00020000000D01: MBAP Header  
 0x10: Function code 10 (Write Multiple Register)  
 0x0001: The Data Address of the first register  
 0x0003: The total number of registers (write 3 registers from 0x0001 to 0x0003)  
 0x03: The number of data bytes to follow (3 bytes)  
 0xFFFF: The value writes to 0x0001. Set all PSU#0-15 at logic "1" (ON)  
 0x0000: The value writes to 0x0002. Set all PSU#16-35 at logic "0" (OFF)  
 0x0000: The value writes to 0x0003. Set all PSU#36-47 at logic "0" (OFF)

Response:

The normal response is an echo of the query, returned after the register contents have been written.

#### 5.3.6.5 Read Array Log (FC=64)

The request message specifies the starting register and quantity of registers to be read.

For example: Client requests the content of analog output holding registers 0x6000 (Event log#1) from the server

Request:

0x00020000000601	0x64	0x6000	0x0001
------------------	------	--------	--------

0x00020000000601: MBAP Header  
 0x64: Function code 64 (Read Array Log)  
 0x6000: The Data Address of the first register requested  
 0x0001: The total number of registers requested (Read only 1 registers from 0x6000)

Response:

Read Array Log is a self-definition of Mean Well, response data frame is as the following

MBAP Header	Function code	Byte Count	Register Value
7 bytes	0x64	N*2	2*N bytes

Byte Count: The byte count field specifies the quantity of complete bytes of data

Register Value: The contents of event log. The data needs to be converted into ASCII codes before reading

Example:

0x00020000004101	0x64	0x3E	0x5053555F32312C46414E 204C6F636B2C32303232 F30312F31322031353A33 343A35360A0000000000 00000000000000000000 00 000000000000000000
------------------	------	------	--

0x00020000004101: MBAP Header  
 0x04: Function code 64 (Read Array Lo)  
 0x3E: The number of data bytes to follow (62 bytes)  
 0x50~00 (62 bytes in total): It means "PSU\_21,FAN Lock,2022/01/12 15:34:56" after converting into ASCII codes

## 6.Maintenance

### 6.1 Firmware update instruction

Firmware updates are infrequent but sometimes may be necessary for older devices due to product compatibility. Please contact our local distributors if you feel the need. You can perform a firmware update by following the instruction below.

Please note that a SD Card is needed and inserted to the CMU2C for a firmware update process.

- ① Click the red mark to add latest firmware files.

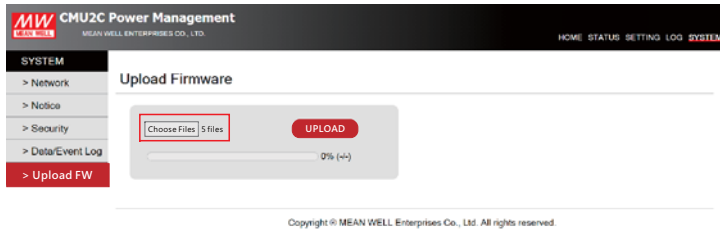

- ② After selecting the correct firmware files, click UPLOAD button to upload firmware to the latest version.

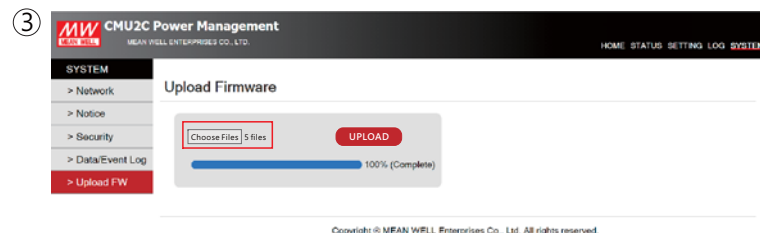
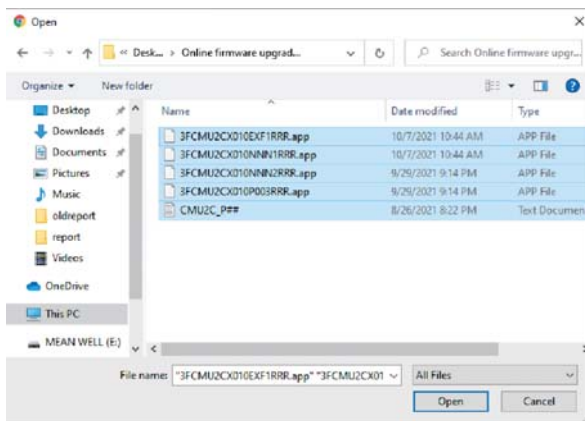

- ④ The latest firmware version will be displayed on the Utility page when the firmware files are uploaded successfully. Tap Update to schedule a firmware update. The firmware update will complete automatically after recycling the CMU2C.

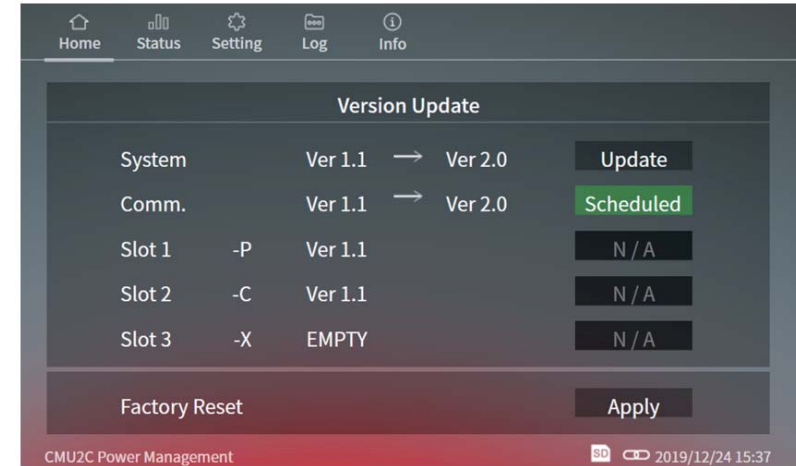

## 7.Warranty

This product provides five years warranty under normal usage. Do not replace parts or any form of modification to the product in order to keep the warranty effectively.

※ MEAN WELL possesses the right to adjust the content of this manual.

Please refer to the latest version of our manual on our website.

<https://www.meanwell.com>



明緯企業股份有限公司

MEAN WELL ENTERPRISES CO., LTD.

248 新北市五股區五權三路28號

No.28, Wuquan 3rd Rd., Wugu Dist., New Taipei City 248, Taiwan

Tel: 886-2-2299-6100 Fax: 886-2-2299-6200

<http://www.meanwell.com> E-mail: [info@meanwell.com](mailto:info@meanwell.com)