



■ Features :

- Universal AC input / Full range (up to 305VAC)
- Built-in active PFC function
- Protections: Short circuit / Over current / Over voltage / Over temperature
- Cooling by free air convection
- Output constant current level adjustable
- Class 2 power unit
- Three in one dimming function (1~10Vdc or PWM signal or resistance)
- Suitable for built in LED lighting system
- Suitable for dry / damp locations
- 100% full load burn-in test
- 3 years warranty



■ GTIN CODE

MW Search: <https://www.meanwell.com/serviceGTIN.aspx>



SPECIFICATION

| MODEL                   | HLP-60H-15                               | HLP-60H-20   | HLP-60H-24 | HLP-60H-30     | HLP-60H-36 | HLP-60H-42    | HLP-60H-48   | HLP-60H-54  |              |  |
|-------------------------|--|--|------------|----------------|------------|---------------|--------------|-------------|--------------|--|
| OUTPUT                  | DC VOLTAGE                               | 15V  | 20V        | 24V            | 30V        | 36V           | 42V          | 48V         | 54V          |  |
|                         | CONSTANT CURRENT REGION Note.4           | 9 ~ 15V  | 12 ~ 20V   | 14.4 ~ 24V     | 18 ~ 30V   | 21.6 ~ 36V    | 25.2 ~ 42V   | 28.8 ~ 48V  | 32.4 ~ 54V   |  |
|                         | RATED CURRENT                            | 4A   | 3A         | 2.5A           | 2A         | 1.7A          | 1.45A        | 1.3A        | 1.15A        |  |
|                         | RATED POWER                              | 60W  | 60W        | 60W            | 60W        | 61.2W         | 60.9W        | 62.4W       | 62.1W        |  |
|                         | RIPPLE & NOISE (max.) Note.2             | 150mVp-p   | 150mVp-p   | 150mVp-p       | 200mVp-p   | 200mVp-p      | 300mVp-p     | 300mVp-p    | 300mVp-p     |  |
|                         | VOLTAGE ADJ. RANGE                       | 13.5 ~ 17V   | 17 ~ 22V   | 22 ~ 27V       | 27 ~ 33V   | 33 ~ 40V      | 40 ~ 46V     | 44 ~ 53V    | 49 ~ 58V     |  |
|                         | CURRENT ADJ. RANGE                       | Can be adjusted by internal potentiometer  |            |                |            |               |              |             |              |  |
|                         |  | 2.4 ~ 4A   | 1.8 ~ 3A   | 1.5 ~ 2.5A     | 1.2 ~ 2A   | 1 ~ 1.7A      | 0.87 ~ 1.45A | 0.78 ~ 1.3A | 0.69 ~ 1.15A |  |
|                         | VOLTAGE TOLERANCE Note.3                 | ±2.0%  | ±1.0%      | ±1.0%          | ±1.0%      | ±1.0%         | ±1.0%        | ±1.0%       | ±1.0%        |  |
|                         | LINE REGULATION                          | ±0.5%  | ±0.5%      | ±0.5%          | ±0.5%      | ±0.5%         | ±0.5%        | ±0.5%       | ±0.5%        |  |
| LOAD REGULATION         | ±1.5%                                    | ±1.0%  | ±0.5%      | ±0.5%          | ±0.5%      | ±0.5%         | ±0.5%        | ±0.5%       |              |  |
| SETUP, RISE TIME Note.6 | 500ms, 80ms at full load 230VAC / 115VAC |  |            |                |            |               |              |             |              |  |
| HOLD UP TIME (Typ.)     | 16ms/230VAC 16ms/115VAC at full load     |  |            |                |            |               |              |             |              |  |
| INPUT                   | VOLTAGE RANGE Note.5                     | 90 ~ 305VAC  |            | 127 ~ 431VDC   |            |               |              |             |              |  |
|                         | FREQUENCY RANGE                          | 47 ~ 63Hz  |            |                |            |               |              |             |              |  |
|                         | POWER FACTOR (Typ.)                      | PF>0.98/115VAC, PF>0.95/230VAC, PF>0.92/277VAC at full load (Please refer to "Power Factor Characteristic" curve)  |            |                |            |               |              |             |              |  |
|                         | TOTAL HARMONIC DISTORTION                | THD< 20% when output loading≥60% at 115VAC/230VAC input and output loading≥75% at 277VAC input   |            |                |            |               |              |             |              |  |
|                         | EFFICIENCY (Typ.)                        | 88%  | 89%        | 89.5%          | 90%        | 90%           | 90%          | 90.5%       | 90.5%        |  |
|                         | AC CURRENT (Typ.)                        | 0.64A / 115VAC   |            | 0.32A / 230VAC |            | 0.3A / 277VAC |              |             |              |  |
|                         | INRUSH CURRENT (Typ.)                    | COLD START 55A(twidth=265µs measured at 50% Ipeak) at 230VAC   |            |                |            |               |              |             |              |  |
|                         | MAX. No. of PSUs on 16A CIRCUIT BREAKER  | 9 units (circuit breaker of type B) / 16 units (circuit breaker of type C) at 230VAC   |            |                |            |               |              |             |              |  |
| LEAKAGE CURRENT         | <0.75mA / 277VAC                         |  |            |                |            |               |              |             |              |  |
| PROTECTION              | OVER CURRENT Note.4                      | 95 ~ 108%<br>Protection type : Constant current limiting, recovers automatically after fault condition is removed  |            |                |            |               |              |             |              |  |
|                         | SHORT CIRCUIT                            | Hiccup mode, recovers automatically after fault condition is removed   |            |                |            |               |              |             |              |  |
|                         | OVER VOLTAGE                             | 18 ~ 24V   | 23 ~ 30V   | 28 ~ 35V       | 35 ~ 43V   | 41 ~ 49V      | 48 ~ 58V     | 54 ~ 65V    | 59 ~ 68V     |  |
|                         | OVER TEMPERATURE                         | Shut down o/p voltage, re-power on to recover  |            |                |            |               |              |             |              |  |
| ENVIRONMENT             | WORKING TEMP.                            | -40 ~ +70°C (Refer to "Derating Curve")  |            |                |            |               |              |             |              |  |
|                         | WORKING HUMIDITY                         | 20 ~ 95% RH non-condensing   |            |                |            |               |              |             |              |  |
|                         | STORAGE TEMP., HUMIDITY                  | -40 ~ +80°C, 10 ~ 95% RH   |            |                |            |               |              |             |              |  |
|                         | TEMP. COEFFICIENT                        | ±0.03%/°C (0 ~ 50°C)   |            |                |            |               |              |             |              |  |
| SAFETY & EMC            | VIBRATION                                | 10 ~ 500Hz, 2G 12min./1cycle, period for 72min. each along X, Y, Z axes  |            |                |            |               |              |             |              |  |
|                         | SAFETY STANDARDS                         | UL8750, CSA C22.2 No. 250.0-08 (except for 48V, 54V), BS EN/EN61347-1, BS EN/EN61347-2-13, EAC TP TC 004 approved ; design refer to UL60950-1, BS EN/EN60335-1 |            |                |            |               |              |             |              |  |
|                         | WITHSTAND VOLTAGE                        | I/P-O/P:3.75KVAC I/P-FG:2KVAC O/P-FG:0.5KVAC   |            |                |            |               |              |             |              |  |
|                         | ISOLATION RESISTANCE                     | I/P-O/P, I/P-FG, O/P-FG:100M Ohms / 500VDC / 25°C / 70% RH   |            |                |            |               |              |             |              |  |
|                         | EMC EMISSION                             | Compliance to BS EN/EN55015, BS EN/EN61000-3-2 Class C (≥60% load) ; BS EN/EN61000-3-3, EAC TP TC 020  |            |                |            |               |              |             |              |  |
| OTHERS                  | EMC IMMUNITY                             | Compliance to BS EN/EN61000-4-2,3,4,5,6,8,11; BS EN/EN61547, BS EN/EN55024, light industry level (surge 4KV), EAC TP TC 020                                    |            |                |            |               |              |             |              |  |
|                         | MTBF                                     | 3130.5K hrs min. Telcordia SR-332(Bellcore) ; 288.5K hrs min. MIL-HDBK-217F (25°C)   |            |                |            |               |              |             |              |  |
|                         | DIMENSION                                | 147*53*27mm (L*W*H)  |            |                |            |               |              |             |              |  |
|                         | PACKING                                  | 0.2Kg;72pcs/15.4Kg/1.01CUFT  |            |                |            |               |              |             |              |  |

NOTE

1. All parameters NOT specially mentioned are measured at 230VAC input, rated load and 25°C of ambient temperature.
2. Ripple & noise are measured at 20MHz of bandwidth by using a 12" twisted pair-wire terminated with a 0.1uf & 47uf parallel capacitor.
3. Tolerance : includes set up tolerance, line regulation and load regulation.
4. Please refer to "DRIVING METHODS OF LED MODULE".
5. Derating may be needed under low input voltages. Please check the static characteristics for more details.
6. Length of set up time is measured at cold first start. Turning ON/OFF the power supply may lead to increase of the set up time.
7. The power supply is considered a component which will be installed into a final equipment. All the EMC tests are been executed by mounting the unit on a 360mm\*360mm metal plate with 1mm of thickness. The final equipment must be re-confirmed that it still meets EMC directives. For guidance on how to perform these EMC tests, please refer to "EMI testing of component power supplies." (as available on [https://www.meanwell.com/Upload/PDF/EMI\\_statement\\_en.pdf](https://www.meanwell.com/Upload/PDF/EMI_statement_en.pdf))
8. Direct connecting to LEDs is suggested, but is not suitable for using additional drivers.
9. To fulfill requirements of the latest ErP regulation for lighting fixtures, this LED power supply can only be used behind a switch without permanently connected to the mains.
10. This product is not suitable for LED lighting applications in China.

※ Product Liability Disclaimer : For detailed information, please refer to <https://www.meanwell.com/serviceDisclaimer.aspx>

### Mechanical Specification

Unit:mm Tolerance:±1

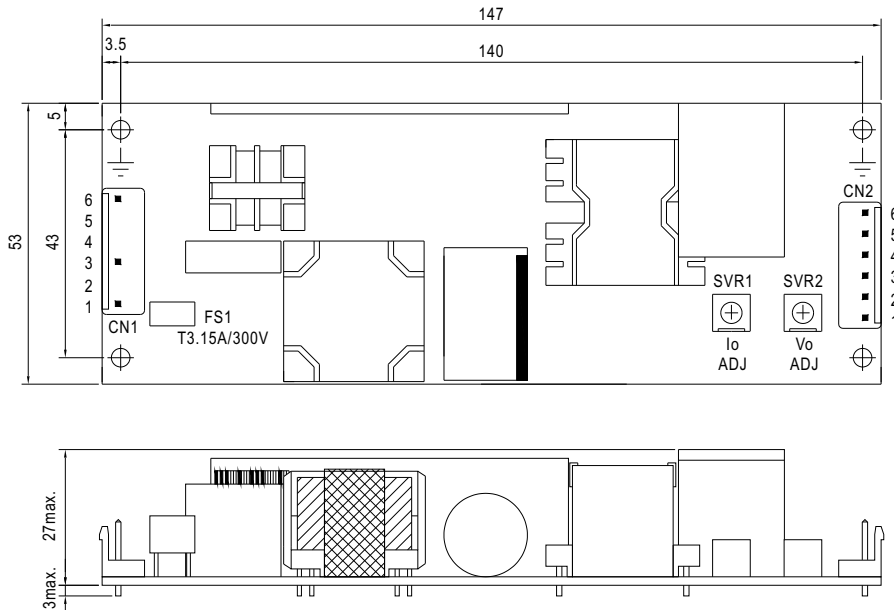

AC Input Connector (CN1) : JST B6P-VH or equivalent

| Pin No. | Assignment | Mating Housing        | Terminal                       |
|---------|------------|-----------------------|--------------------------------|
| 1       | AC/L       | JST VHR or equivalent | JST SVH-21T-P1.1 or equivalent |
| 2,4,5   | No Pin     |                       |                                |
| 3       | AC/N       |                       |                                |
| 6       | FG $\perp$ |                       |                                |

DC Output Connector (CN2) : JST B6P-VH or equivalent

| Pin No. | Assignment | Mating Housing        | Terminal                       |
|---------|------------|-----------------------|--------------------------------|
| 1       | DIM+       | JST VHR or equivalent | JST SVH-21T-P1.1 or equivalent |
| 2       | DIM-       |                       |                                |
| 3,4     | -V         |                       |                                |
| 5,6     | +V         |                       |                                |

$\perp$  : Grounding required

### Block Diagram

fosc : 100KHz

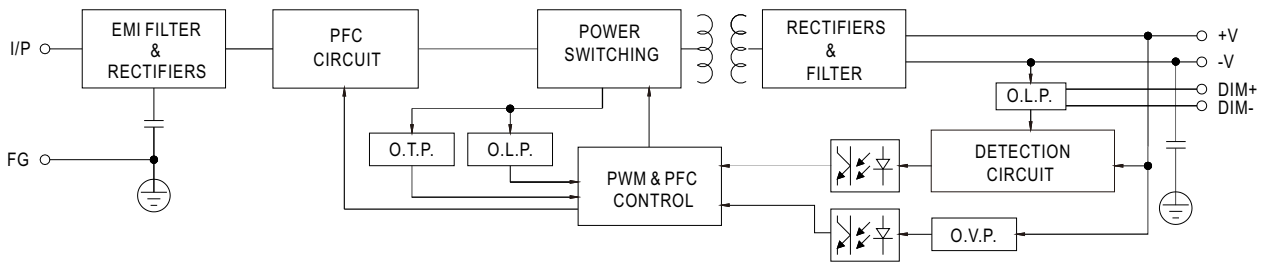

### Derating Curve

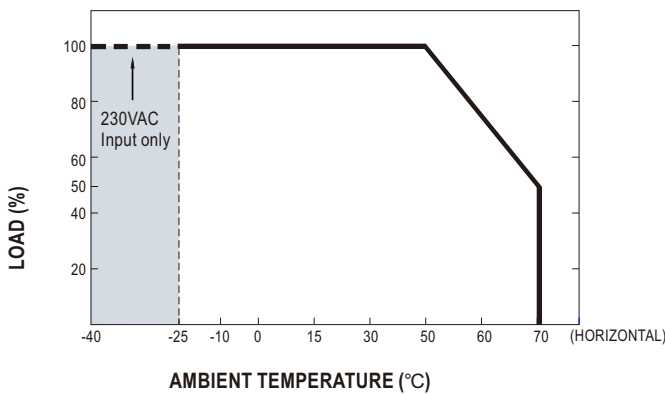

### Static Characteristics

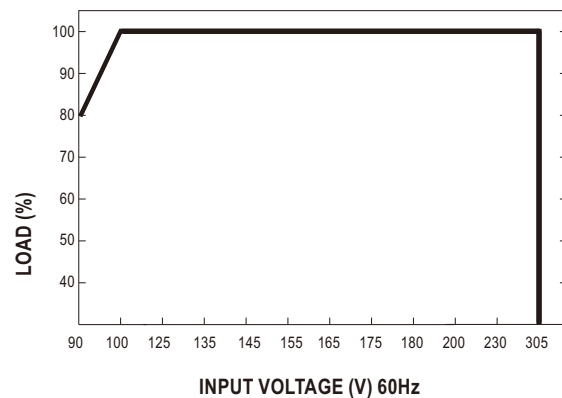

**Power Factor Characteristic**

Constant Current Mode

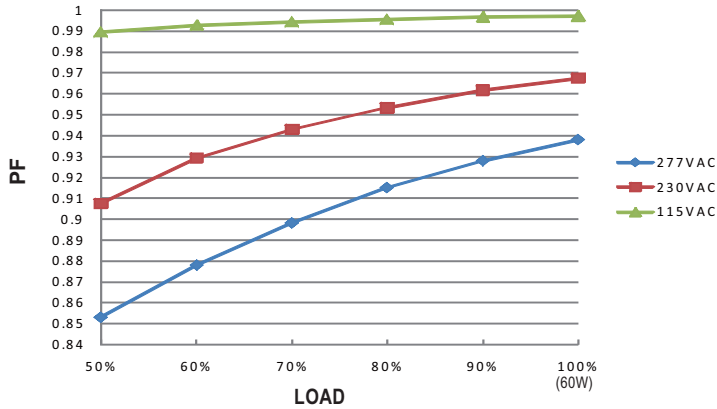

**EFFICIENCY vs LOAD (48V Model)**

HLP-60H series possess superior working efficiency that up to 90.5% can be reached in field applications.

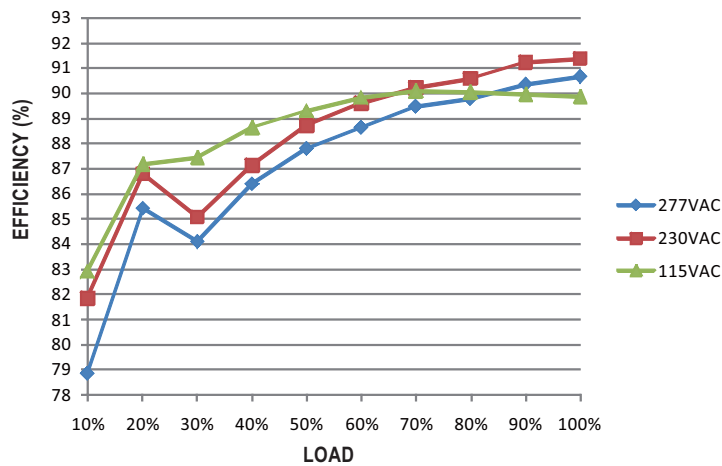

**DRIVING METHODS OF LED MODULE**

This LED power supply is suggested to work in constant current mode area (CC) to drive the LEDs.

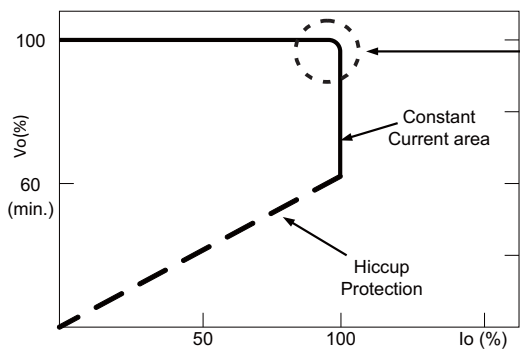

Typical LED power supply I-V curve

In the constant current region, the highest voltage at the output of the driver depends on the configuration of the end systems.

Should there be any compatibility issues, please contact MEAN WELL.

**■ DIMMING OPERATION**

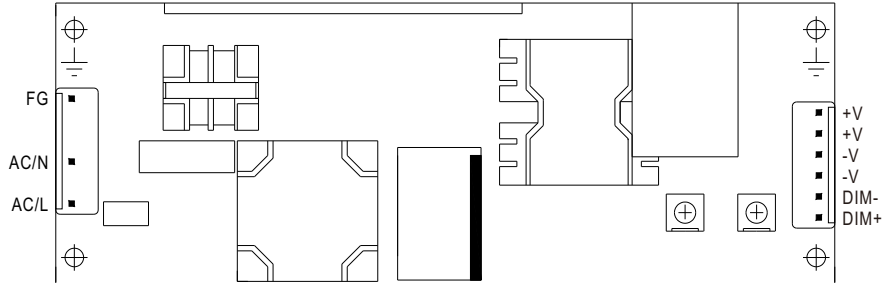

※ Output constant current level can be adjusted through output connector by 1~10VDC, PWM signal, or connecting a resistance between DIM+ and DIM-.

※ Please DO NOT connect "DIM-" to "-V".

※ Reference resistance value for output current adjustment (Typical)

| Resistance value            | Single driver  | 10KΩ   | 20KΩ   | 30KΩ   | 40KΩ   | 50KΩ   | 60KΩ   | 70KΩ   | 80KΩ   | 90KΩ   | 100KΩ   | OPEN     |
|-----------------------------|--|--------|--------|--------|--------|--------|--------|--------|--------|--------|---------|----------|
|                             | Multiple drivers<br>(N=driver quantity for synchronized dimming operation) | 10KΩ/N | 20KΩ/N | 30KΩ/N | 40KΩ/N | 50KΩ/N | 60KΩ/N | 70KΩ/N | 80KΩ/N | 90KΩ/N | 100KΩ/N | -----    |
| Percentage of rated current |  | 10%    | 20%    | 30%    | 40%    | 50%    | 60%    | 70%    | 80%    | 90%    | 100%    | 95%~108% |

※ 1 ~ 10V dimming function for output current adjustment (Typical)

| Dimming value               | 1V  | 2V  | 3V  | 4V  | 5V  | 6V  | 7V  | 8V  | 9V  | 10V  | OPEN     |
|-----------------------------|-----|-----|-----|-----|-----|-----|-----|-----|-----|------|----------|
| Percentage of rated current | 10% | 20% | 30% | 40% | 50% | 60% | 70% | 80% | 90% | 100% | 95%~108% |

※ 10V PWM signal for output current adjustment (Typical): Frequency range : 100Hz ~ 3KHz

| Duty value                  | 10% | 20% | 30% | 40% | 50% | 60% | 70% | 80% | 90% | 100% | OPEN     |
|-----------------------------|-----|-----|-----|-----|-----|-----|-----|-----|-----|------|----------|
| Percentage of rated current | 10% | 20% | 30% | 40% | 50% | 60% | 70% | 80% | 90% | 100% | 95%~108% |

※ Using the built-in dimming function can't turn the lighting fixture totally dark. Please refer to the connection method below to achieve 0% brightness of the lighting fixture connecting to the LED power supply unit.

Dimming connection diagram for turning the lighting fixture ON/OFF :

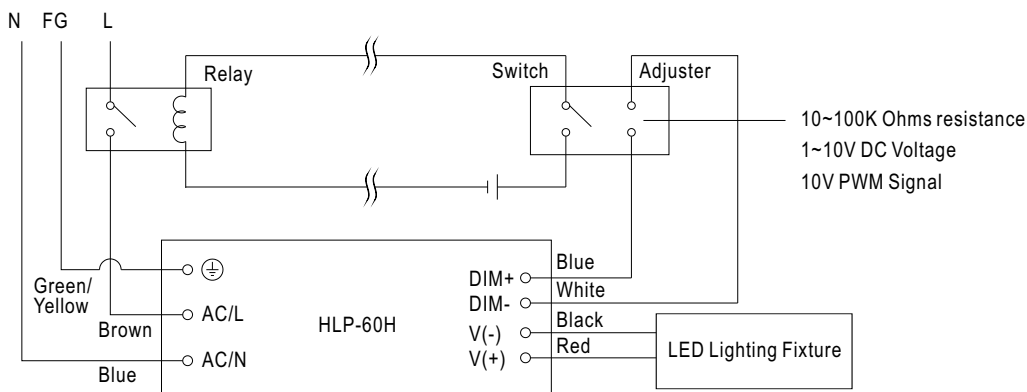

Using a switch and relay can turn ON/OFF the lighting fixture.

1. Output constant current level can be adjusted through output connector by connecting a resistance or 1~10Vdc or 10V PWM signal between DIM+ and DIM-.
2. The LED lighting fixture can be turned ON/OFF by the switch.