



Test Report: NSP-1000-36

1000W AC/DC High Reliable Multi-Industrial Enclosed Type Power Supply

■ DESIGN VERIFY TEST

Output Function Test

Input Function Test

Protection Function Test

Control Function Test

Component Stress Test

■ SAFETY & E.M.C. TEST

Safety Test

E.M.C. Test

■ RELIABILITY TEST

ENVIRONMENT TEST

■ DESIGN VERIFY TEST

OUTPUT FUNCTION TEST

NO	TEST ITEM	SPECIFICATION	TEST CONDITION	RESULT
1	OUTPUT VOLTAGE ADJUST RANGE	CH1: 32.4 V~ 43.2 V	I/P : 230 VAC O/P : MIN LOAD Ta : 25°C	CH1: 30.6V~44.5V/230VAC
2	OUTPUT VOLTAGE TOLERANCE	V1: -1%~ 1%	I/P: 85VAC /305VAC O/P:FULL/ MIN. LOAD Ta:25°C	V1: -0.03% ~ + 0.08%
3	LINE REGULATION	V1: -0.5%~ 0.5%	I/P: 85VAC~ 305VAC O/P:FULL LOAD Ta:25°C	V1: -0.06% ~ + 0.00%
4	LOAD REGULATION	V1: -0.5%~ 0.5%	I/P: 230VAC O/P:FULL ~MIN LOAD Ta:25°C	V1: - 0.08%~ +0.00%
5	OVER/UNDERSHOOT TEST	< ± 5%	I/P: 230VAC O/P:FULL LOAD Ta:25°C	1.98 %
6	RIPPLE & NOISE (Max)	V1: 300 mVp-p	I/P: 230 VAC O/P: MIN LOAD—FULL LOAD Ta:25°C	V1: 133mVp-p / 100% load

high frequency :

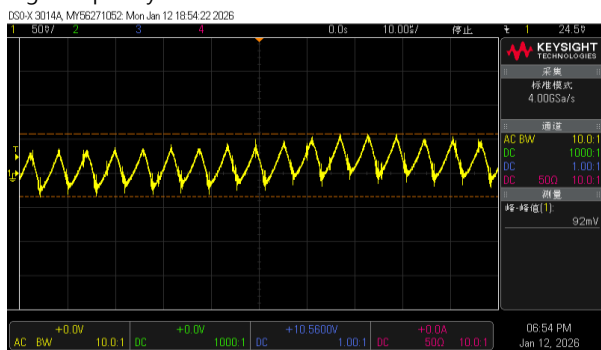

low frequency :

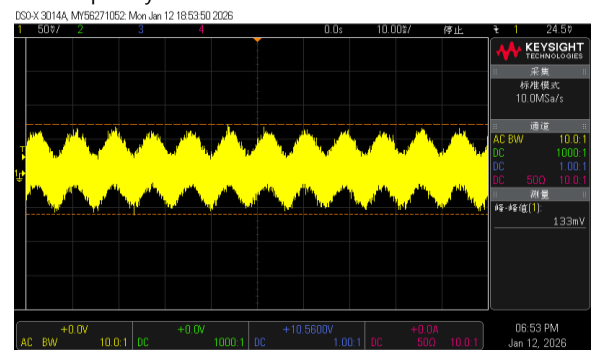

7	SET UP TIME(Max)	277VAC/1500ms 230VAC/1500ms 115VAC/2500ms	I/P : 277VAC I/P : 230VAC I/P : 115VAC O/P : FULL LOAD Ta : 25°C	277VAC/ 1220 ms 230VAC/ 1250 ms 115VAC/ 2000 ms
---	------------------	---	--	---

INPUT=277VAC/60HZ @ FULL LOAD
CH1 : Output Voltage CH2 : AC Input Voltage

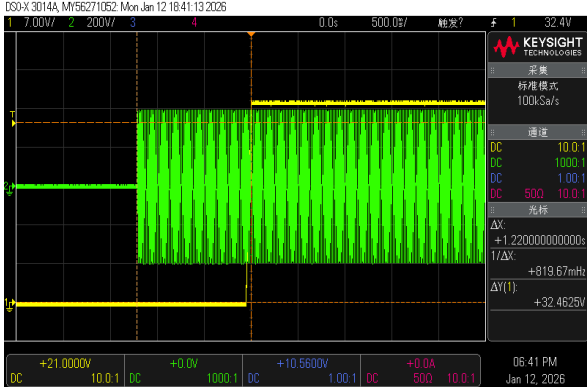

INPUT=230VAC/50HZ @ FULL LOAD
CH1 : Output Voltage CH2 : AC Input Voltage

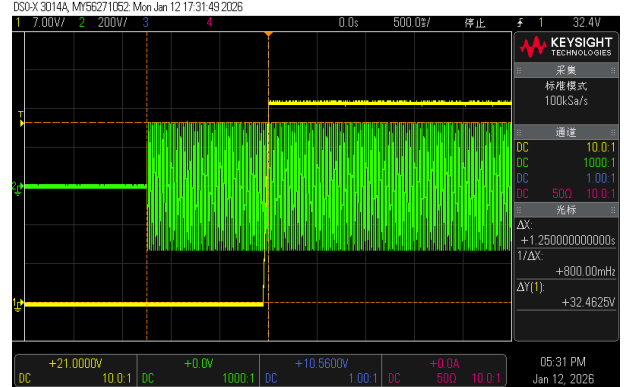

INPUT=115VAC/60HZ @ FULL LOAD
CH1 : Output Voltage CH2 : AC Input Voltage

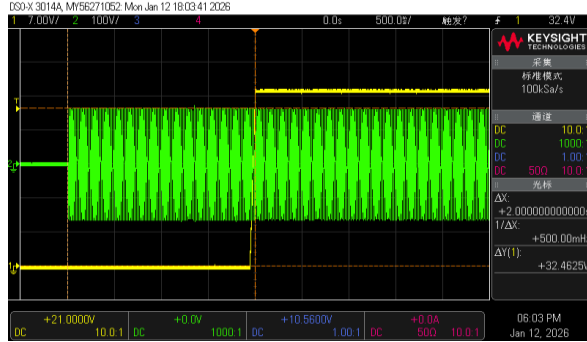

8 RISE TIME (Max)

277VAC/80ms
230VAC/80ms
115VAC/80ms

I/P : 277VAC
I/P : 230VAC
I/P : 115VAC
O/P : FULL LOAD
Ta : 25°C

277VAC/ 46 ms
230VAC/ 46 ms
115VAC/ 46 ms

INPUT=277VAC/60HZ @ FULL LOAD
CH1 : Output Voltage

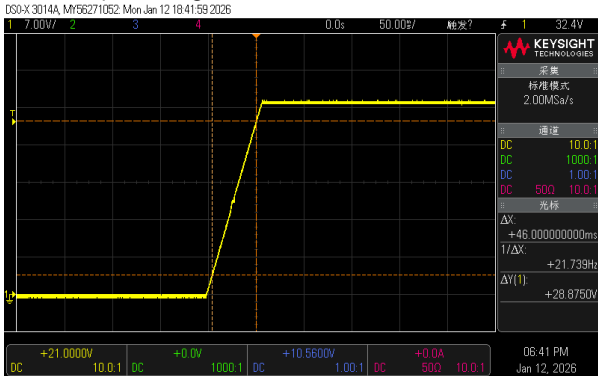

INPUT=230VAC/50HZ @ FULL LOAD
CH1 : Output Voltage

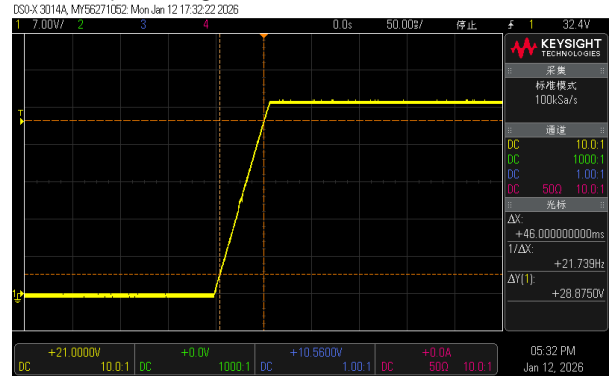

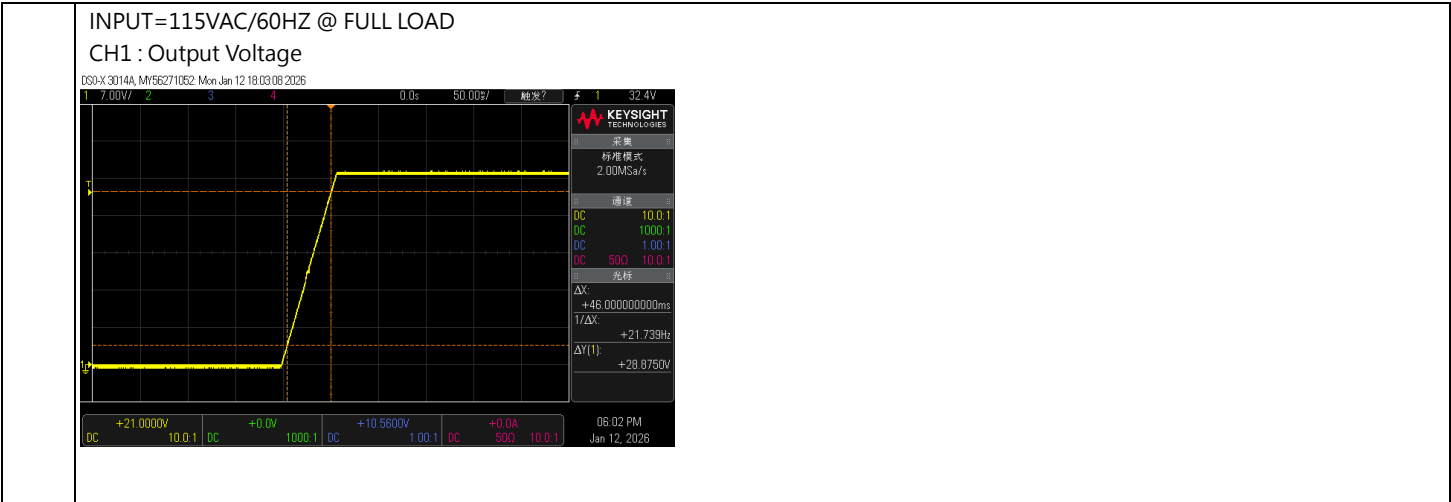

9	HOLD UP TIME (Typ.)	12ms@70%load 8ms@full load	I/P : 277 VAC I/P : 230VAC I/P : 115 VAC O/P : 70%LOAD/FULL LOAD Ta : 25°C	277VAC: 32ms/26ms 230VAC: 34ms/24ms 115VAC: 32ms/24ms
---	---------------------	-------------------------------	--	---

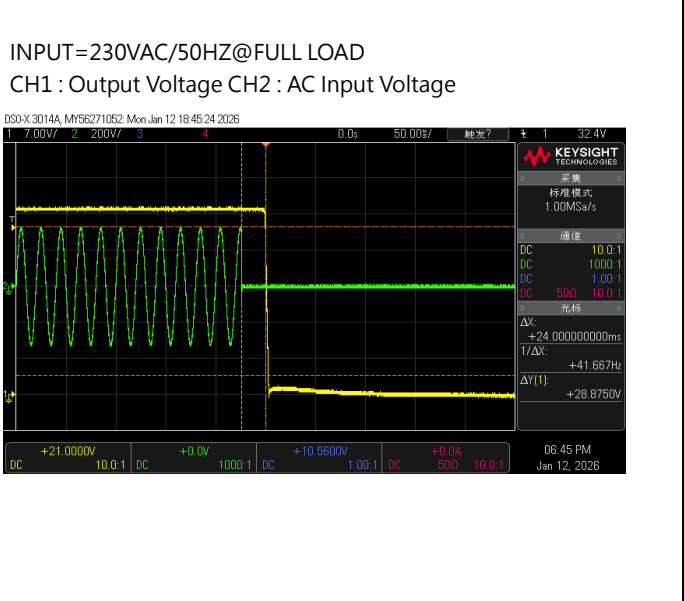
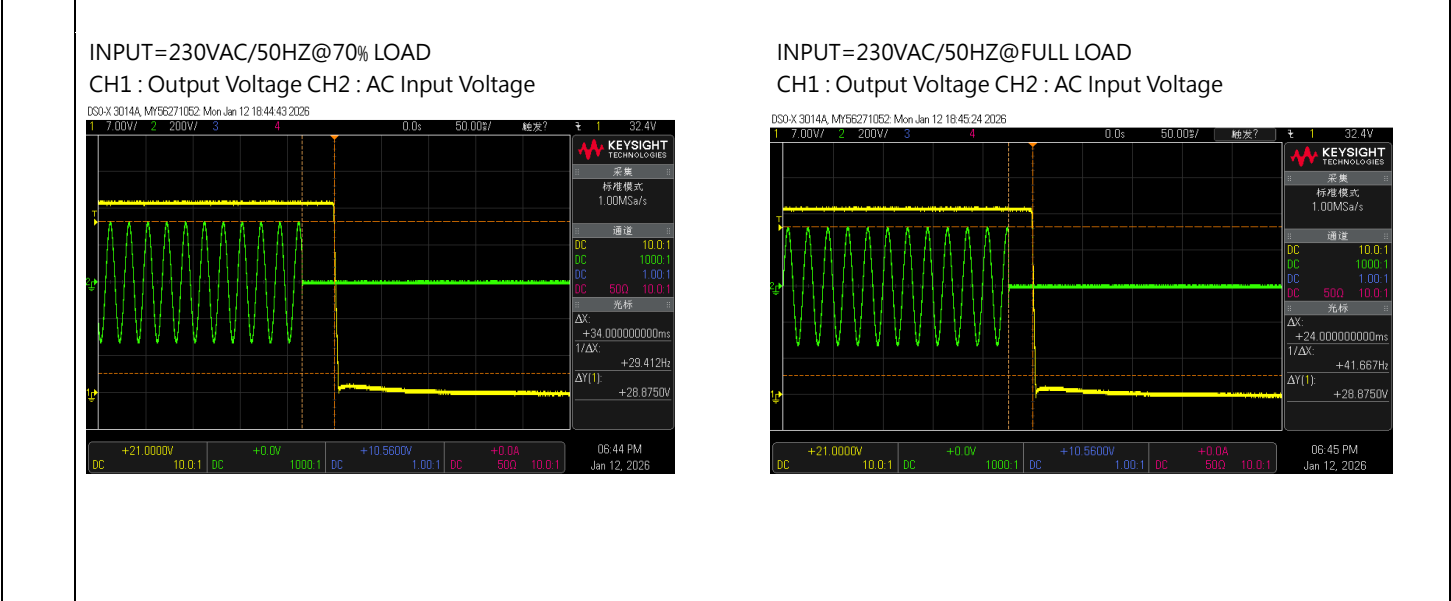
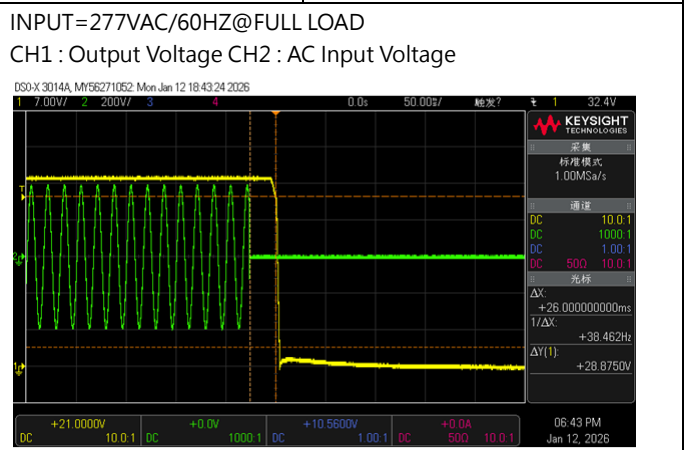
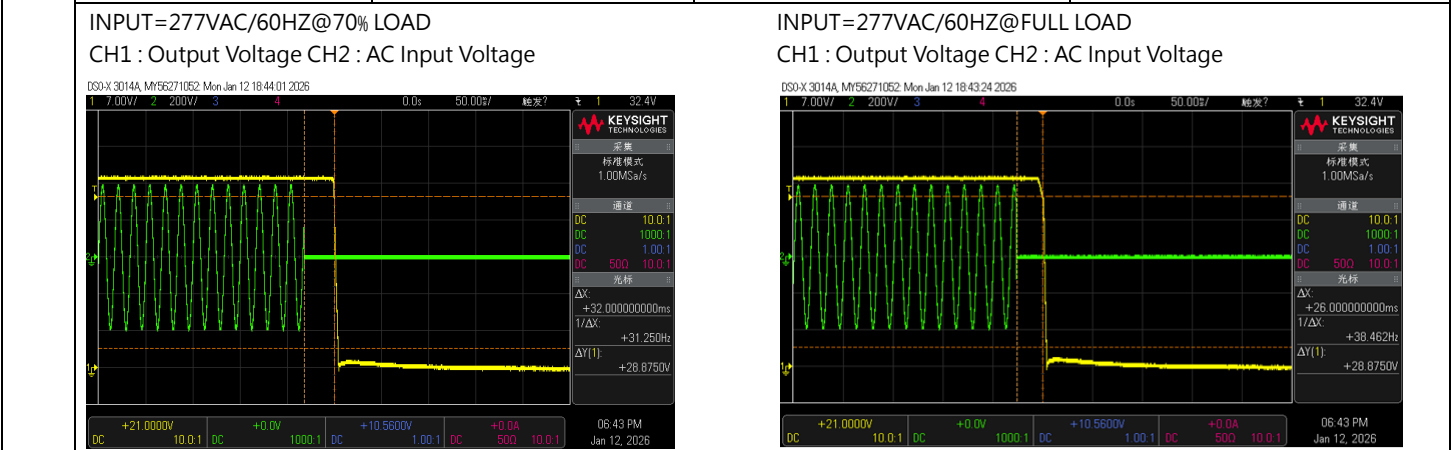

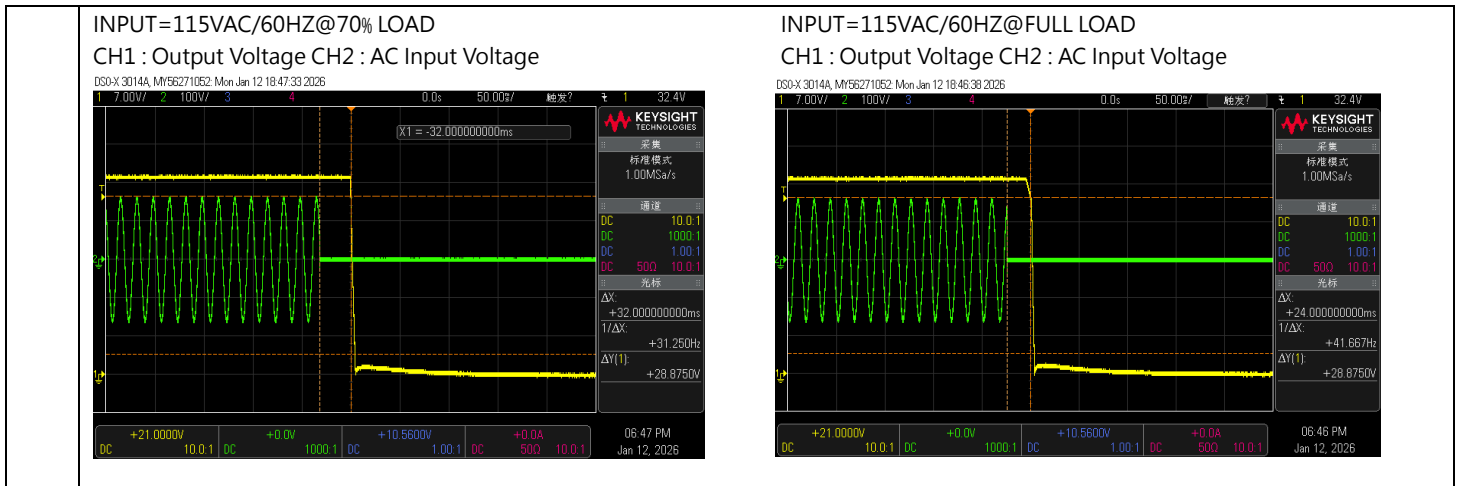

10	DYNAMIC LOAD	V1: 7200 mVp-p	I/P: 230VAC O/P: (1)FULL /50% LOAD 50%DUTY / 120HZ (2)FULL /50% LOAD 50%DUTY / 1KHZ Ta:25°C	470mVp-p 390mVp-p
----	--------------	----------------	---	--------------------------

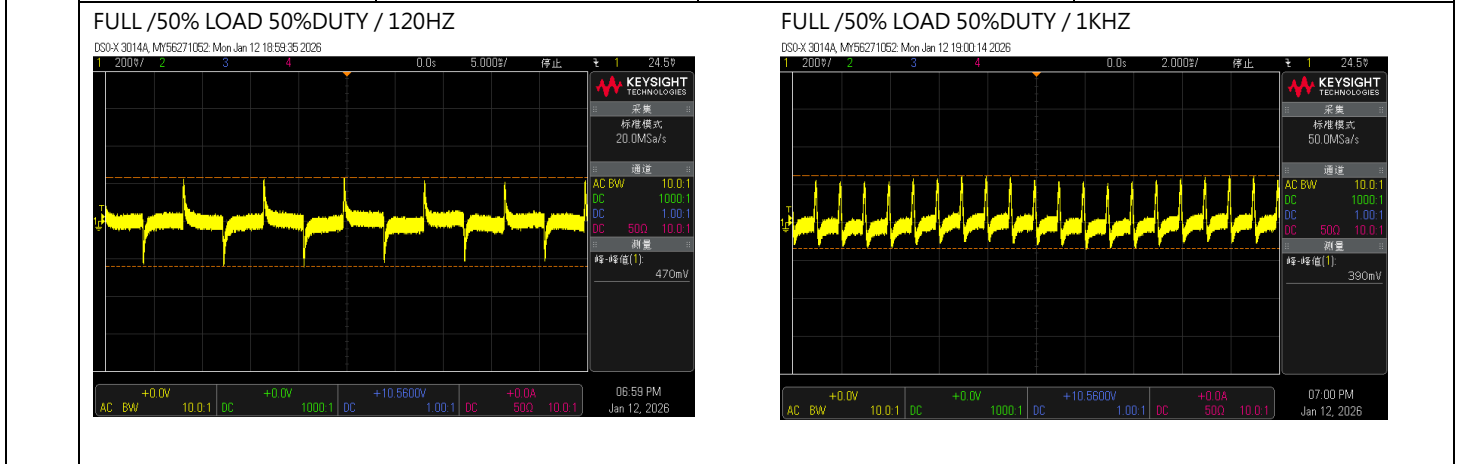

INPUT FUNCTION TEST

NO	TEST ITEM	SPECIFICATION	TEST CONDITION	RESULT
1	INPUT VOLTAGE RANGE	85VAC~305VAC 120VDC~ 431VDC	(1) I/P:TESTING O/P:FULL LOAD (2) I/P: DC TESTING (L: + N :-) O/P: FULL / 50% LOAD (3) I/P:DC TESTING(L:- N:+) O/P: FULL / 50% LOAD Ta:25°C	(1) 85 V ~ 305V (2) 120 Vdc~431Vdc/FULL LOAD 120Vdc~ 431Vdc/50% LOAD (3) 120Vdc~431Vdc/FULL LOAD 120 Vdc~ 431Vdc/50% LOAD
			I/P: LOW-LINE-3V=82V HIGH-LINE+10V=315 V O/P:FULL/MIN LOAD (PLEASE CHECK DERATING CURVE) ON: 30 Sec OFF: 30 Sec 10MIN (POWER ON/OFF NO DAMAGE)	TEST: OK
2	INPUT FREQUENCY RANGE	47HZ ~63 HZ NO DAMAGE	I/P:85VAC ~264 VAC O/P:FULL~MIN LOAD Ta:25°C	TEST: OK
3	INPUT CURRENT (Typ.)	277V/ 5A 230V/ 6A 115V/ 12A	I/P : 277VAC I/P : 230VAC I/P : 115VAC O/P : FULL LOAD Ta : 25°C	I =3.96 A/ 277VAC I =4.70 A/ 230VAC I =9.56 A/ 115VAC
4	LEAKAGE CURRENT	Earth leakage current < 350μA(rms)@277VAC	I/P : 277 VAC O/P : Min LOAD Ta : 25°C	L-FG : 204μA N-FG : 206μA
		Touch current <100μA (rms)@277 VAC		L-V+ : 76.4 μA L-V- : 76.2 μA N-V+ : 76.4 μA N-V- : 76.2 μA
5	POWER FACTOR (Typ.)	0.92/277VAC 0.95/ 230VAC 0.98/ 115VAC	I/P : 277VAC I/P : 230VAC I/P : 115VAC O/P : FULL LOAD Ta : 25°C	PF= 0.963/277VAC PF= 0.983/230VAC PF= 0.995/115VAC

P.F vs LOAD

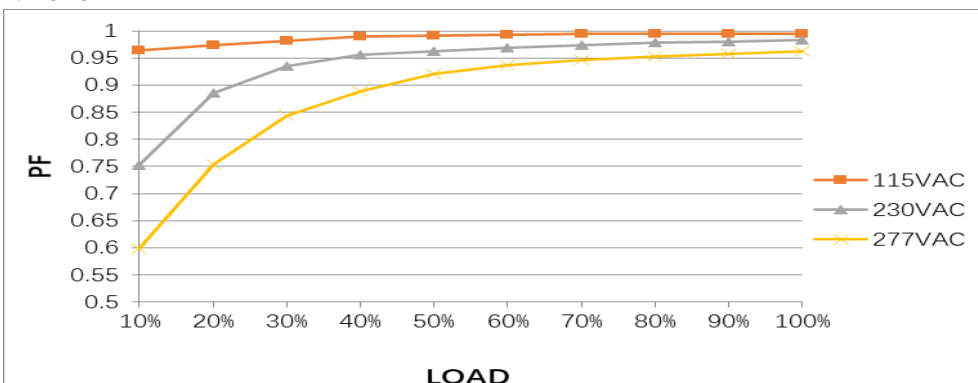

6	EFFICIENCY(Typ.)	93.5 %	I/P:230 VAC O/P:FULL LOAD Ta:25°C	93.9 %
---	------------------	--------	---	--------

EFFICIENCY vs LOAD

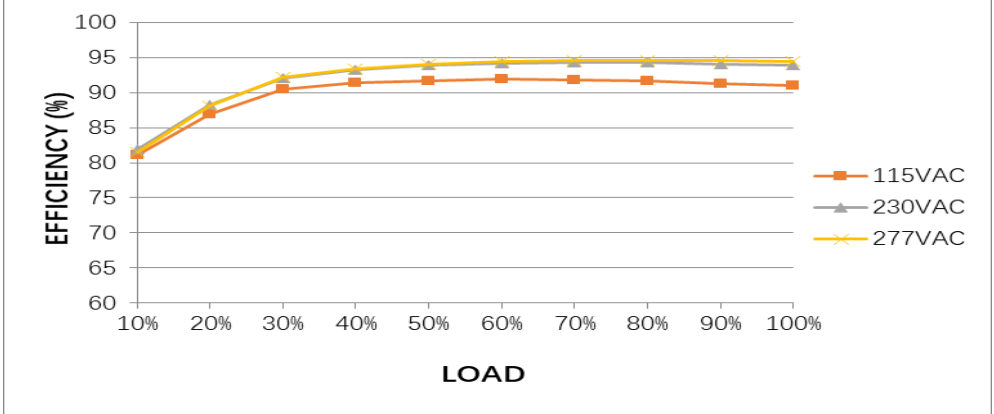

7	INRUSH CURRENT(Typ.)	50A/277VAC 40A/230VAC 25A/115VAC COLD START	I/P : 277VAC I/P : 230VAC I/P : 115VAC O/P : FULL LOAD Ta : 25°C	I = 34.5A/ 277VAC T50= 2080us/277V I = 29.7A/230VAC T50= 2240us/230V I = 15.7A/ 115VAC T50=1270 us/115V
---	----------------------	--	--	--

INPUT=277VAC/50HZ @ FULL LOAD

CH2 : AC Input Voltage CH4 : Input current

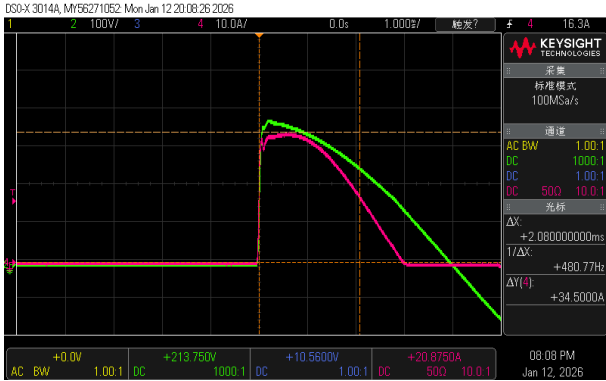

INPUT=230VAC/50HZ @ FULL LOAD

CH2 : AC Input Voltage CH4 : Input current

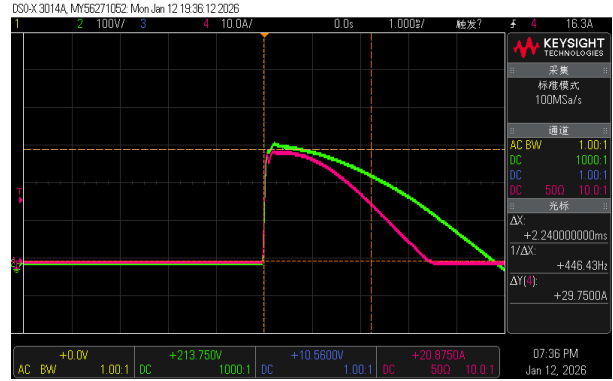

INPUT=115VAC/50HZ @ FULL LOAD

CH2 : AC Input Voltage CH4 : Input current

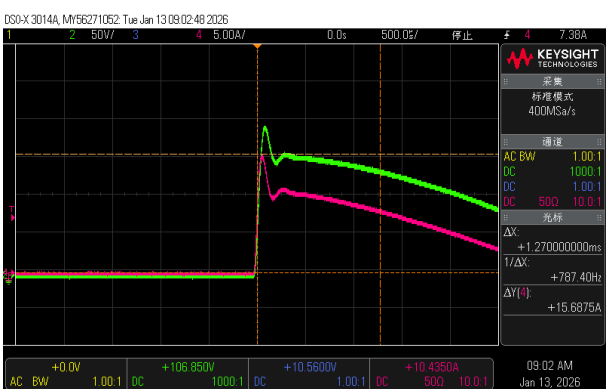

PROTECTION FUNCTION TEST





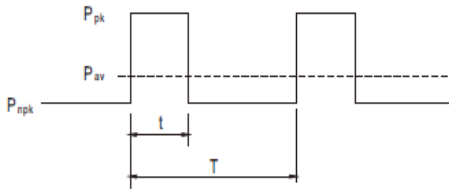
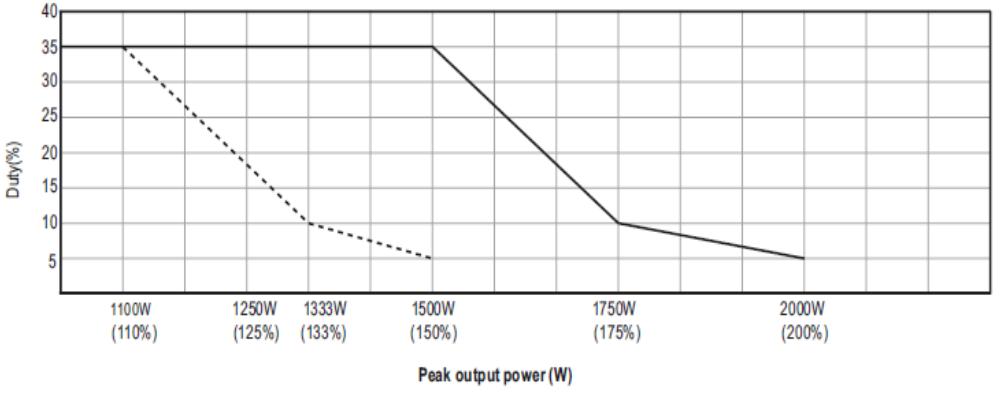

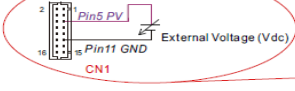
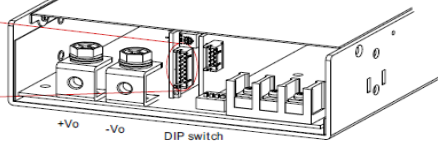
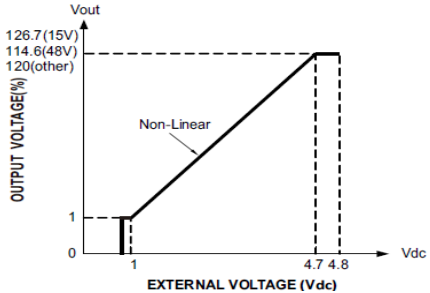
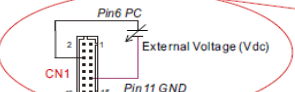
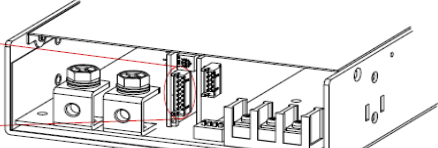
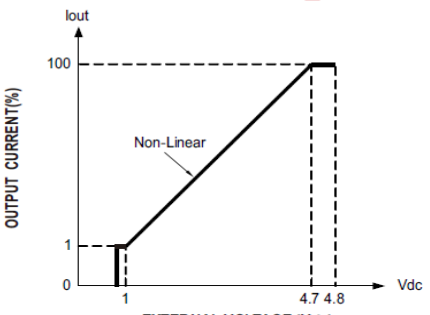

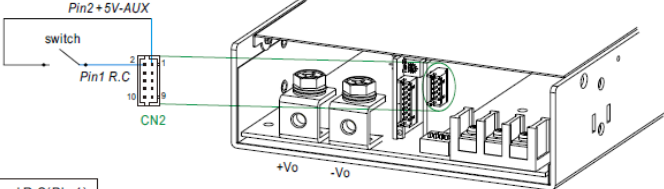
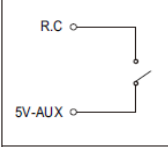
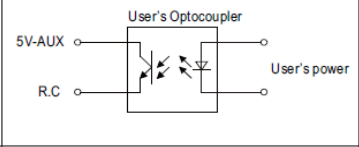
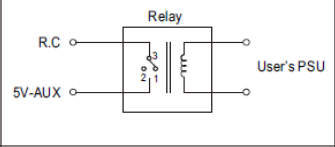
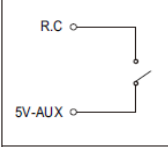
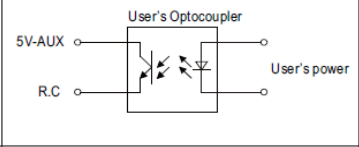
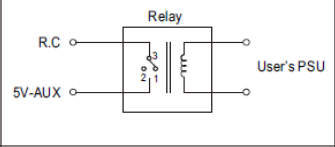
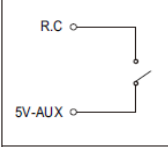
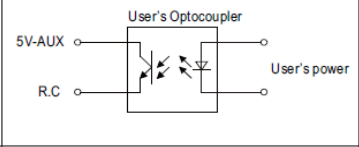
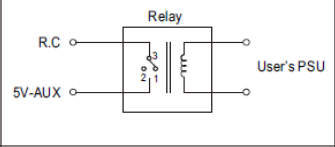







































NO	TEST ITEM	SPECIFICATION	TEST CONDITION	RESULT
1	OVER LOAD PROTECTION	105 % ~ 200 %	I/P: 305VAC I/P: 230VAC I/P: 85VAC O/P: TESTING Ta: 25°C	109.35%/ 305VAC 109.35%/ 230VAC 109.35%/ 85VAC Protection type : Peak Load Mode: From 105% to 200% of rated output power, unit will shut down after 5 seconds of continuous operation. AC repower on to recover. At >200% of rated output power, constant current limiting is activated. Unit will shut down after 5 seconds of continuous operation. AC repower on to recover. Current Limiting Mode: Constant current limiting, recovers automatically after abnormal condition is removed.
2	OVER VOLTAGE PROTECTION	44 V ~ 54 V	I/P: 305VAC I/P: 230VAC I/P: 85VAC O/P: MIN LOAD Ta: 25°C	51.0 V/ 305VAC 51.0 V/ 230VAC 50.6 V/ 85VAC Protection type : Shut down and latch off output voltage, re-power on to recover
3	OVER TEMPERATURE PROTECTION	NO DAMAGE	I/P: 305VAC I/P: 85VAC O/P: FULL LOAD	O.T.P. Active Protection type : Shut down output voltage, recovers automatically after temperature goes down
4	SHORT PROTECTION	SHORT EVERY OUTPUT 1 HOUR NO DAMAGE	I/P: 305VAC I/P: 85VAC O/P: FULL LOAD Ta: 25°C	NO DAMAGE Protection type : Peak Load Mode: Constant current limiting, unit will shut down after 5 Sec, AC repower on to recover. Current Limiting Mode: Constant current limiting, recovers automatically after abnormal condition is removed.

CONTROL FUNCTION TEST

NO	TEST ITEM	SPECIFICATION	TEST CONDITION	RESULT
1	PEAK POWER	<p>■ Function Manual</p> <p>1. Peak Power</p> $P_{av} = \frac{P_{pk} \times t + P_{rpk} \times (T-t)}{T} \leq P_{rated}$ $Duty = \frac{t}{T} \times 100\% \leq 35\%$ $t \leq 5 \text{ sec}$  <p> P_{pk}: Peak output power (W) P_{rpk}: Non-peak output power (W) P_{rated}: Rated output power (W) t: Peak power width(sec) T: Period(sec) </p>  <p> For example (24V model) $V_{in}=220Vac, Duty_max=5\%$ $P_{av}=P_{rated}=1000W$ $P_{pk}=2000W$ $t \leq 5sec$ $T \geq \frac{5sec}{5\%} = 100sec$ $P_{rpk} \leq \frac{TP_{av}-tP_{pk}}{T-t} = 947.4W$ </p> <p>Note: When the output voltage is adjusted to the upper limit, the peak power is 150% of rated power</p>		<p>I/P: 100/200 VAC O/P: PEAK LOAD Ta: 25°C TEST RESULT : OK</p>

<p>2</p> <p>OUTPUT VOLTAGE PROGRAMMABLE(PV)</p>	<p>2. Output Voltage Programming(P.V)</p> <p>(1)Default by potentiometer (SVR) (a)Set DIP switch position-3 to OFF(refer to the illustration on the right). (b)Output voltage can be trimmed by SVR.</p> <p>(2)By Output Voltage Programming (a)Set DIP switch position-3 to ON(refer to the illustration on the right). (b)The output voltage can be trimmed to 0~120% by applying EXTERNAL VOLTAGE between PV and GND on CN1.</p>    <p>I/P: 230 VAC O/P:FULL LOAD Ta:25°C TEST RESULT : PASS</p> <table border="1" data-bbox="502 974 1532 1153"> <tr> <td>External voltage(DC)</td> <td><0.4V</td> <td>1V</td> <td>2.524V</td> <td>4.7V</td> <td>4.8V</td> </tr> <tr> <td>SPEC(%)</td> <td>0%</td> <td>0%~6%</td> <td>50%±5%</td> <td>120%±5%</td> <td>120%±5%</td> </tr> <tr> <td>Vout(%)</td> <td>0%</td> <td>0.353V(0.98%)</td> <td>17.42V(48.39%)</td> <td>42.11V(116.97%)</td> <td>43.23V(120.08%)</td> </tr> </table>	External voltage(DC)	<0.4V	1V	2.524V	4.7V	4.8V	SPEC(%)	0%	0%~6%	50%±5%	120%±5%	120%±5%	Vout(%)	0%	0.353V(0.98%)	17.42V(48.39%)	42.11V(116.97%)	43.23V(120.08%)
External voltage(DC)	<0.4V	1V	2.524V	4.7V	4.8V														
SPEC(%)	0%	0%~6%	50%±5%	120%±5%	120%±5%														
Vout(%)	0%	0.353V(0.98%)	17.42V(48.39%)	42.11V(116.97%)	43.23V(120.08%)														
<p>3</p> <p>OUTPUT CURRENT PROGRAMMABLE (PC)</p>	<p>3. Output Current Programming(P.C)</p> <p>(1)Default Overload Protection(OLP) value (a)Set DIP switch position-2 to OFF(refer to the illustration on the right). (b)Output current is set default value.</p> <p>(2)By Constant Current Level Programming (a)Set DIP switch position-2 to ON(refer to the illustration on the right). (b)The constant current level can be trimmed to 0~100% of the rated current by applying EXTERNAL VOLTAGE between PC and GND on CN1.</p>    <p>I/P: 230 VAC O/P:TESTING Ta:25°C</p> <table border="1" data-bbox="502 1881 1532 2027"> <tr> <td>External voltage(DC)</td> <td><0.4V</td> <td>1V</td> <td>2.831V</td> <td>4.7V</td> <td>4.8V</td> </tr> <tr> <td>SPEC(%)</td> <td>0%</td> <td>0~6%</td> <td>50%±5%</td> <td>100%±5%</td> <td>100%±5%</td> </tr> <tr> <td>Iout(%)</td> <td>0%</td> <td>1.42%</td> <td>51.08%</td> <td>101.08%</td> <td>101.08%</td> </tr> </table>	External voltage(DC)	<0.4V	1V	2.831V	4.7V	4.8V	SPEC(%)	0%	0~6%	50%±5%	100%±5%	100%±5%	Iout(%)	0%	1.42%	51.08%	101.08%	101.08%
External voltage(DC)	<0.4V	1V	2.831V	4.7V	4.8V														
SPEC(%)	0%	0~6%	50%±5%	100%±5%	100%±5%														
Iout(%)	0%	1.42%	51.08%	101.08%	101.08%														

<p>4</p> <p>REMOTE CONTROL</p>	<p>4.Remote Control</p> <p>※ The power supply can be turned ON/OFF individually or along with other units by using the "Remote Control" function with external switch, photocoupler or relay.</p>  <table border="1" data-bbox="531 539 970 629"> <tr> <td>PSU Vo Status</td> <td>Between +5V-AUX(Pin 2) and R.C(Pin 1)</td> </tr> <tr> <td>Power ON</td> <td>Switch Short</td> </tr> <tr> <td>Power OFF</td> <td>Switch Open</td> </tr> </table> <table border="1" data-bbox="531 651 1394 875"> <tr> <td></td> <td></td> <td></td> </tr> <tr> <td>R.C. by external switch.</td> <td>R.C. by user's optocoupler control module.</td> <td>R.C. by user's Relay control module.</td> </tr> </table> <p>I/P: 230 VAC O/P:FULL LOAD Ta:25°C Test Result : PASS</p> <table border="1" data-bbox="507 1059 1230 1173"> <tr> <td>Between +5V-AUX(Pin2) and R.C(Pin1)</td> <td>Power Supply Status</td> </tr> <tr> <td>SW SHORT</td> <td>ON</td> </tr> <tr> <td>SW OPEN</td> <td>OFF</td> </tr> </table>	PSU Vo Status	Between +5V-AUX(Pin 2) and R.C(Pin 1)	Power ON	Switch Short	Power OFF	Switch Open				R.C. by external switch.	R.C. by user's optocoupler control module.	R.C. by user's Relay control module.	Between +5V-AUX(Pin2) and R.C(Pin1)	Power Supply Status	SW SHORT	ON	SW OPEN	OFF
PSU Vo Status	Between +5V-AUX(Pin 2) and R.C(Pin 1)																		
Power ON	Switch Short																		
Power OFF	Switch Open																		
																			
R.C. by external switch.	R.C. by user's optocoupler control module.	R.C. by user's Relay control module.																	
Between +5V-AUX(Pin2) and R.C(Pin1)	Power Supply Status																		
SW SHORT	ON																		
SW OPEN	OFF																		
<p>5</p> <p>REMOTE SENSE</p>	<table border="1"> <tr> <td>S+ / S->0.5V Compensate voltage drop on the load wiring up to 0.5V.</td> <td>I/P: 230 VAC O/P:FULL LOAD Ta:25°C</td> <td>> 0.5V</td> </tr> </table>	S+ / S->0.5V Compensate voltage drop on the load wiring up to 0.5V.	I/P: 230 VAC O/P:FULL LOAD Ta:25°C	> 0.5V															
S+ / S->0.5V Compensate voltage drop on the load wiring up to 0.5V.	I/P: 230 VAC O/P:FULL LOAD Ta:25°C	> 0.5V																	
<p>6</p> <p>AUXILIARY POWER</p>	<p>1.Auxiliary voltage output, 10.2~13.8V, referenced to GND-AUX (pin2). The maximum load current is 0.8A. This output has the built-in "Oring diodes" and is not controlled by "Remote ON-OFF.</p> <p>2.Auxiliary voltage output, 4.25~5.75V, referenced to GND-AUX (pin2). The maximum load current is 0.3A. This output has the built-in "Oring diodes" and is not controlled by "Remote ON-OFF</p> <p>I/P: 230 VAC O/P:FULL LOAD Ta:25°C Test Result : PASS</p> <table border="1" data-bbox="588 1697 1425 1843"> <thead> <tr> <th>AUX</th> <th>TOLERANCE</th> <th>RIPPLE</th> <th>TEST RESULT</th> </tr> </thead> <tbody> <tr> <td>12V / 0.8A</td> <td>10.2~13.8V</td> <td>450mVp-p</td> <td>11.85V/74 mV</td> </tr> <tr> <td>5V / 0.2A</td> <td>4.25~5.75V</td> <td>150mVp-p</td> <td>4.94V/84mV</td> </tr> </tbody> </table>	AUX	TOLERANCE	RIPPLE	TEST RESULT	12V / 0.8A	10.2~13.8V	450mVp-p	11.85V/74 mV	5V / 0.2A	4.25~5.75V	150mVp-p	4.94V/84mV						
AUX	TOLERANCE	RIPPLE	TEST RESULT																
12V / 0.8A	10.2~13.8V	450mVp-p	11.85V/74 mV																
5V / 0.2A	4.25~5.75V	150mVp-p	4.94V/84mV																
<p>7</p> <p>DC OK SIGNAL</p>	<p>I/P:230VAC O/P: FULL LOAD Ta:25°C TEST: OK</p>																		

8	LED Status indicators	<p>※ LED Status Indicators</p> <table border="1" data-bbox="507 300 1538 1077"> <thead> <tr> <th data-bbox="507 300 978 342">Description</th> <th colspan="3" data-bbox="978 300 1538 342">Output of alarm</th> </tr> </thead> <tbody> <tr> <td data-bbox="507 342 978 423">Normal operation</td> <td data-bbox="978 342 1230 423">Green : Steadily lit</td> <td data-bbox="1230 342 1321 423"></td> <td data-bbox="1321 342 1538 423"></td> </tr> <tr> <td data-bbox="507 423 978 504">Remote off</td> <td data-bbox="978 423 1230 504">Red : Steadily lit</td> <td data-bbox="1230 423 1321 504"></td> <td data-bbox="1321 423 1538 504"></td> </tr> <tr> <td data-bbox="507 504 978 584">Internal over-temperature</td> <td data-bbox="978 504 1230 584">Orange : 1 Blink/Pause</td> <td data-bbox="1230 504 1321 584"></td> <td data-bbox="1321 504 1538 584"></td> </tr> <tr> <td data-bbox="507 584 978 665">Overload/Short</td> <td data-bbox="978 584 1230 665">Red : 1 Blink/Pause</td> <td data-bbox="1230 584 1321 665"></td> <td data-bbox="1321 584 1538 665"></td> </tr> <tr> <td data-bbox="507 665 978 745">Over voltage</td> <td data-bbox="978 665 1230 745">Red : 2 Blink/Pause</td> <td data-bbox="1230 665 1321 745"></td> <td data-bbox="1321 665 1538 745"></td> </tr> <tr> <td data-bbox="507 745 978 826">Over temperature</td> <td data-bbox="978 745 1230 826">Red : 3 Blink/Pause</td> <td data-bbox="1230 745 1321 826"></td> <td data-bbox="1321 745 1538 826"></td> </tr> <tr> <td data-bbox="507 826 978 907">Fan fail</td> <td data-bbox="978 826 1230 907">Red : 4 Blink/Pause</td> <td data-bbox="1230 826 1321 907"></td> <td data-bbox="1321 826 1538 907"></td> </tr> <tr> <td data-bbox="507 907 978 987">AC under voltage</td> <td data-bbox="978 907 1230 987">Red : 5 Blink/Pause</td> <td data-bbox="1230 907 1321 987"></td> <td data-bbox="1321 907 1538 987"></td> </tr> <tr> <td data-bbox="507 987 978 1068">Others (Note)</td> <td data-bbox="978 987 1230 1068">Red : 6 Blink/Pause</td> <td data-bbox="1230 987 1321 1068"></td> <td data-bbox="1321 987 1538 1068"></td> </tr> </tbody> </table> <p data-bbox="507 1093 1455 1144">Note: 1. Others include hardware fault etc. 2. In PC mode, both OLP and SCP operate in constant current limiting, with the indicator steadily lit green.</p> <p data-bbox="507 1189 663 1323">I/P:230VAC O/P:FULL LOAD Ta:25°C TEST : PASS</p>			Description	Output of alarm			Normal operation	Green : Steadily lit			Remote off	Red : Steadily lit			Internal over-temperature	Orange : 1 Blink/Pause			Overload/Short	Red : 1 Blink/Pause			Over voltage	Red : 2 Blink/Pause			Over temperature	Red : 3 Blink/Pause			Fan fail	Red : 4 Blink/Pause			AC under voltage	Red : 5 Blink/Pause			Others (Note)	Red : 6 Blink/Pause		
Description	Output of alarm																																											
Normal operation	Green : Steadily lit																																											
Remote off	Red : Steadily lit																																											
Internal over-temperature	Orange : 1 Blink/Pause																																											
Overload/Short	Red : 1 Blink/Pause																																											
Over voltage	Red : 2 Blink/Pause																																											
Over temperature	Red : 3 Blink/Pause																																											
Fan fail	Red : 4 Blink/Pause																																											
AC under voltage	Red : 5 Blink/Pause																																											
Others (Note)	Red : 6 Blink/Pause																																											
9	FAN NOISE (Typ.)	<p>10% load @18 dB 70% load @24 dB</p> <p>Built-in intelligent fan speed control detect by PSU' S internal temperature</p>	<p>I/P : 230 VAC O/P : TESTING Ta : 25°C</p>	<p>10% load: 16.52dB 70% load: 22.92dB</p>																																								

COMPONENT STRESS TEST

NO	TEST ITEM	SPECIFICATION	TEST CONDITION	RESULT
1	PWM Transistor (D to S) or (C to E) Peak Voltage	Q53 Rated: 650V/33.7A	AC ON/OFF I/P:High-Line +3V =308V VDS: O/P: (1)Full Load (2)Output Short (3)Dynamic Load Full Load/ Min. Load 90%Duty/1KHz (4)Dynamic Load Full Load/ Min. Load 90%Duty/3KHz (5)Dynamic Load Full Load/ Min. Load 90%Duty/5KHz (6)Dynamic Load 100% Load/ Min. Load 50%Duty/120Hz (7)0%→400% Load. (8)0%~150%LOAD (9)0%LOAD~SHORT I/P:Low-Line -3V = 82V O/P: (1)Full Load (2)Output Short (3)Dynamic Load Full Load/ Min. Load 90%Duty/1KHz (4)Dynamic Load Full Load/ Min. Load 90%Duty/3KHz (5)Dynamic Load Full Load/ Min. Load 90%Duty/5KHz (6)Dynamic Load 100% Load/ Min. Load 50%Duty/120Hz (7)0%→400% Load. Ta:25°C	VDS: (1) 442V (2) 466V (3) 446V (4) 446V (5) 446V (6) 446V (7) 454V (8) 30.1V (9) 47.2V VDS: (1) 462V (2) 466V (3) 470V (4) 470V (5) 470V (6) 462V (7) 470V
2	Diode Peak Voltage	Q100 Rated: 60A/250V Q103 Rated: 60A/250V	AC ON/OFF I/P:High-Line +3V =308 V O/P: (1)Full Load (2)Output Short (3)Dynamic Load Full Load/ Min. Load 90%Duty/1KHz (4)Dynamic Load Full Load/ Min. Load 90%Duty/3KHz (5)Dynamic Load Full Load/ Min. Load 90%Duty/5KHz (6)Dynamic Load 100% Load/ Min. Load 50%Duty/120Hz (7)0%→400% Load. (8).NO LOAD Ta:25°C	Q100: VDS: (1) 160V (2) 150V (3) 172V (4) 152V (5) 152V (6) 172V (7) 170V (8) 168V

				<p>Q103: VDS: (1) 168V (2) 160V (3) 172V (4) 160V (5) 160V (6) 170V (7) 170V (8) 172V</p>
3	Input Capacitor Voltage	<p>C5 Rated: 470μ/450V Surge voltage: 495V</p>	<p>I/P:High-Line +3V =308V O/P: (1)Full Load input on/off (2) Min load input on /Off (3)Full Load /Min load Change (4)Full load continue Ta:25°C</p>	<p>(1)446V (2)438V (3)454V (4)450V</p>
4	Control IC Voltage Test	<p>PWM IC U500 Rated 8V~ 30 V</p> <p>PFC IC U1 Rated 11.9V~ 25V</p> <p>O/P IC U100 Rated 4.2 V~ 30 V</p>	<p>AC ON/OFF I/P:High-Line +3V =308 V O/P(1)FULL LOAD (2) Output Short (3)O.L.P (4)O.V.P. (5)NO LOAD VRmin(Low LINE) Ta:25°C</p>	<p>U500 (1) 17.5V (2) 17.7V (3) 17.5V (4) 17.9V (5) 17.5V</p> <p>U1 (1) 18.1V (2) 18.1V (3) 18.1V (4) 18.1V (5) 18.1V</p> <p>U100 (1) 12.3V (2) 12.5V (3) 12.3V (4) 12.5V (5) 12.3V</p>

■ SAFETY & E.M.C. TEST

SAFETY TEST

NO	TEST ITEM	SPECIFICATION	TEST CONDITION	RESULT
1	WITHSTAND VOLTAGE	I/P-O/P: 4 K VAC/min I/P-FG : 2 K VAC/min O/P-FG: 1.5 KVAC/min	I/P-O/P: 4.4 KVAC/min I/P-FG: 2.4 KVAC/min O/P-FG: 1.8 KVAC/min Ta:25°C	I/P-O/P: 3.52 mA I/P-FG: 2.36 mA O/P-FG: 2.23 mA NO DAMAGE
2	ISOLATION RESISTANCE	I/P-O/P: 500 VDC>100MΩ I/P-FG: 500 VDC>100MΩ O/P-FG: 500 VDC >100MΩ	I/P-O/P: 500 VDC I/P-FG: 500 VDC O/P-FG: 500 VDC Ta:25°C	I/P-O/P: >9999 MΩ I/P-FG: >9999 MΩ O/P-FG: >9999 MΩ NO DAMAGE
3	GROUNDING CONTINUITY	FG(PE) TO CHASSIS OR TRACE < 100 mΩ	40A / 2min Ta:25°C	15 mΩ

E.M.C TEST

NO	TEST ITEM	SPECIFICATION	TEST CONDITION	RESULT
1	HARMONIC	EN61000-3-2 CLASS A	I/P:230VAC/50HZ O/P:FULL LOAD Ta:25°C	PASS
2	CONDUCTION	EN55032 EN55014-1 EN55011	I/P : 230 VAC (50HZ) O/P : FULL/50% LOAD Ta : 25°C	PASS Test by certified Lab
3	RADIATION	EN55032 EN55014-1 EN55011	I/P : 230 VAC (50HZ) O/P : FULL LOAD Ta : 25°C	PASS Test by certified Lab
4	E.S.D	EN61000-4-2 AIR : 15KV / Contact : 8KV	I/P : 230 VAC/50HZ O/P : FULL LOAD Ta : 25°C	CRITERIA A
5	E.F.T	EN61000-4-4 INPUT : 2KV	I/P : 230 VAC/50HZ O/P : FULL LOAD Ta : 25°C	CRITERIA A
6	SURGE	IEC61000-4-5 L-N : 2KV L,N-PE : 4KV	I/P : 230 VAC/50HZ O/P : FULL LOAD Ta : 25°C	CRITERIA A
7	Test by certified Lab & Test Report Prepare Any contradictions of the test results, please refer to the latest EMC test report			

■ RELIABILITY TEST

ENVIRONMENT TEST

NO	TEST ITEM	SPECIFICATION	TEST CONDITION	RESULT																																																																																																								
1	TEMPERATURE RISE TEST	MODEL : NSP-1000-24 1. ROOM AMBIENT BURN-IN : 2HRS I/P : 230VAC O/P : FULL LOAD Ta=27.5 °C 2. HIGH AMBIENT BURN-IN : 2HRS I/P : 230VAC O/P : FULL LOAD Ta=60.9 °C																																																																																																										
				<table border="1"> <thead> <tr> <th>NO</th> <th>Position</th> <th>ROOM AMBIENT Ta=27.5 °C</th> <th>HIGH AMBIENT Ta=60.9 °C</th> </tr> </thead> <tbody> <tr><td>1</td><td>LF2</td><td>34.2°C</td><td>67.6°C</td></tr> <tr><td>2</td><td>BD1</td><td>52.7°C</td><td>86.1°C</td></tr> <tr><td>3</td><td>Q1</td><td>53.3°C</td><td>86.7°C</td></tr> <tr><td>4</td><td>D4</td><td>50.7°C</td><td>84.1°C</td></tr> <tr><td>5</td><td>L1</td><td>41.2°C</td><td>74.6°C</td></tr> <tr><td>6</td><td>C5</td><td>36.4°C</td><td>69.8°C</td></tr> <tr><td>7</td><td>U1</td><td>40.6°C</td><td>74.0°C</td></tr> <tr><td>8</td><td>U2</td><td>45.4°C</td><td>78.8°C</td></tr> <tr><td>9</td><td>Q50</td><td>55.5°C</td><td>88.9°C</td></tr> <tr><td>10</td><td>Q51</td><td>59.4°C</td><td>92.8°C</td></tr> <tr><td>11</td><td>Q52</td><td>50.3°C</td><td>83.7°C</td></tr> <tr><td>12</td><td>Q53</td><td>52.8°C</td><td>86.2°C</td></tr> <tr><td>13</td><td>L3</td><td>74.2°C</td><td>107.6°C</td></tr> <tr><td>14</td><td>T1</td><td>63.7°C</td><td>97.1°C</td></tr> <tr><td>15</td><td>D100</td><td>59.5°C</td><td>92.9°C</td></tr> <tr><td>16</td><td>L100</td><td>49.8°C</td><td>83.2°C</td></tr> <tr><td>17</td><td>C110</td><td>39.4°C</td><td>72.8°C</td></tr> <tr><td>18</td><td>U100</td><td>64.1°C</td><td>97.5°C</td></tr> <tr><td>19</td><td>Q102</td><td>56.9°C</td><td>90.3°C</td></tr> <tr><td>20</td><td>R118</td><td>66.4°C</td><td>99.8°C</td></tr> <tr><td>21</td><td>RTH5</td><td>36.6°C</td><td>70.0°C</td></tr> <tr><td>22</td><td>RTH6</td><td>41.6°C</td><td>75.0°C</td></tr> <tr><td>23</td><td>RT31</td><td>41.6°C</td><td>75.0°C</td></tr> <tr><td>24</td><td>RT32</td><td>40.1°C</td><td>73.5°C</td></tr> <tr><td>25</td><td>C14</td><td>35.3°C</td><td>68.7°C</td></tr> </tbody> </table>	NO	Position	ROOM AMBIENT Ta=27.5 °C	HIGH AMBIENT Ta=60.9 °C	1	LF2	34.2°C	67.6°C	2	BD1	52.7°C	86.1°C	3	Q1	53.3°C	86.7°C	4	D4	50.7°C	84.1°C	5	L1	41.2°C	74.6°C	6	C5	36.4°C	69.8°C	7	U1	40.6°C	74.0°C	8	U2	45.4°C	78.8°C	9	Q50	55.5°C	88.9°C	10	Q51	59.4°C	92.8°C	11	Q52	50.3°C	83.7°C	12	Q53	52.8°C	86.2°C	13	L3	74.2°C	107.6°C	14	T1	63.7°C	97.1°C	15	D100	59.5°C	92.9°C	16	L100	49.8°C	83.2°C	17	C110	39.4°C	72.8°C	18	U100	64.1°C	97.5°C	19	Q102	56.9°C	90.3°C	20	R118	66.4°C	99.8°C	21	RTH5	36.6°C	70.0°C	22	RTH6	41.6°C	75.0°C	23	RT31	41.6°C	75.0°C	24	RT32	40.1°C	73.5°C	25	C14	35.3°C	68.7°C
NO	Position	ROOM AMBIENT Ta=27.5 °C	HIGH AMBIENT Ta=60.9 °C																																																																																																									
1	LF2	34.2°C	67.6°C																																																																																																									
2	BD1	52.7°C	86.1°C																																																																																																									
3	Q1	53.3°C	86.7°C																																																																																																									
4	D4	50.7°C	84.1°C																																																																																																									
5	L1	41.2°C	74.6°C																																																																																																									
6	C5	36.4°C	69.8°C																																																																																																									
7	U1	40.6°C	74.0°C																																																																																																									
8	U2	45.4°C	78.8°C																																																																																																									
9	Q50	55.5°C	88.9°C																																																																																																									
10	Q51	59.4°C	92.8°C																																																																																																									
11	Q52	50.3°C	83.7°C																																																																																																									
12	Q53	52.8°C	86.2°C																																																																																																									
13	L3	74.2°C	107.6°C																																																																																																									
14	T1	63.7°C	97.1°C																																																																																																									
15	D100	59.5°C	92.9°C																																																																																																									
16	L100	49.8°C	83.2°C																																																																																																									
17	C110	39.4°C	72.8°C																																																																																																									
18	U100	64.1°C	97.5°C																																																																																																									
19	Q102	56.9°C	90.3°C																																																																																																									
20	R118	66.4°C	99.8°C																																																																																																									
21	RTH5	36.6°C	70.0°C																																																																																																									
22	RTH6	41.6°C	75.0°C																																																																																																									
23	RT31	41.6°C	75.0°C																																																																																																									
24	RT32	40.1°C	73.5°C																																																																																																									
25	C14	35.3°C	68.7°C																																																																																																									
2	OVER LOAD BURN-IN TEST	NO DAMAGE 1 HOUR (MIN)	I/P : 230 VAC O/P : 109 % LOAD Ta : 25°C	TEST : OK																																																																																																								
3	LOW TEMPERATURE TURN ON TEST	TURN ON AFTER 2 HOUR	I/P : 305VAC/100VAC O/P : 60%/ 100 % LOAD Ta= -45/-35 °C	TEST : OK																																																																																																								



4	HIGH HUMIDITY HIGH TEMPERATURE HIGH VOLTAGE TURN ON TEST	AFTER 12 HOURS IN CHAMBER ON CONTROL 60 °C/95 %R.H NO DAMAGE	I/P : 315 VAC O/P : FULL LOAD Ta= 65 °C HUMIDITY= 95 %R.H	TEST : OK
5	TEMPERATURE COEFFICIENT	±0.03 %/°C(0~60°C)	I/P : 230 VAC O/P : FULL LOAD	± 0.0023 %/°C(0~60°C)
6	STORAGE TEMPERATURE TEST	-40~85°C	1. Thermal shock Temperature : -45°C~ +90°C 2. Temperature change rate : 25°C / MIN 3. Dwell time low and high temperature : 30 MIN/EACH 4. Total test cycle : 10 CYCLE 5. Input/output condition : STATIC	
7	THERMAL SHOCK TEST	-30~60°C	1. Thermal shock Temperature : -35°C~ +65°C 2. Temperature change rate : 25°C / MIN 3. Dwell time low and high temperature : 30 MIN/EACH 4. Total test cycle : 16 CYCLE 5. Input/output condition : 15cycle:230V/ FULL LOAD AC ON 3sec/AC OFF 1sec TEST 1cycle:230V/ FULL LOAD Burn In Test	
8	VIBRATION TEST	10 ~ 500Hz, 2G 10min./1cycle, 60min. each along X, Y, Z axes	(1) Waveform : Sine Wave (2) Frequency : 10~500Hz (3) Sweep Time : 10min/sweep cycle (4) Acceleration : 3G (5) Test Time : 180min in each axis (X.Y.Z) (6) Ta : 25°C	
9	CAPACITOR LIFE CYCLE	SUPPOSE C110 IS THE MOST CRITICAL COMPONENT (1) I/P : 230VAC O/P : FULL LOAD Ta=25 °C LIFE TIME (2) I/P : 230VAC O/P : FULL LOAD Ta=60 °C LIFE TIME (3) I/P : 230VAC O/P : 75% LOAD Ta=60 °C LIFE TIME (4) I/P : 230VAC O/P : 50% LOAD Ta=60 °C LIFE TIME	(1) 796346HRS (2) 140775HRS (3) 198948HRS (4) 236666HRS	
10	MTBF	Conducted by Parts Stress Analysis Prediction 910.8K hrs min. Telcordia SR-332 (Bellcore) ; 87.5K hrs min. MIL-HDBK-217F (25°C)		
11	Ongoing Reliability Test	I/P : 230VAC O/P : FULL LOAD TA=50°C Demonstration Mean Time Between Failure : 50,000 hours		

TEST RESULT	TESTER	REVIEW	APPROVAL
PASS	WUWQIN/ZHOUBIAO	WENF	WUWQ

2020.10.1 TAG-QA-009