

**Features**

- 85~305Vac input with PFC(277Vac available)
- Global certificates in multi-fields(ITE 62368-1, Medical 60601-1, Household 60335-1, Industrial 61558-1/2-16/61010-1/-2-201, Energy converter 62477-1) & SEMI47 approved
- 200% peak power capability
- High efficiency up to 94%
- Output voltage 0~120% and output current 0~100% programmable
- Current sharing up to 4000W(3+1) for parallel use
- Built-in OR-ing FET (by request, Order NO.: NSP-1000-xxOR/MODOR)
- CANBus Built-in or MODBus protocol (by request)
- -40~+85°C wide range operation temperature(> +60°C derating)
- Extremely low leakage current<350uA, 2 x MOPP, suitable for BF medical applications
- Built in constant current limiting circuit
- Protections: Short circuit / Overload / Over voltage / Over temperature
- Built-in remote ON/OFF control/Remote Sense/ DC OK signal
- 5 Vaux and 12 Vaux power
- Over voltage category III (OVC III)
- Operating altitude up to 5000 meters
- Built-in intelligent fan speed control, low noise <45dB
- Conformal coating
- 5 years warranty

**Applications**

- Industrial automation machinery/control system
- Security system
- Mechanical and electrical equipment
- Electronic instruments, equipments or apparatus
- Network equipment
- Telecom devices
- Power sourcing equipment of PoE
- Home automation
- Medical devices
- Supercapacitor

**GTIN CODE**

MW Search: <https://www.meanwell.com/serviceGTIN.aspx>

**Description**

The NSP-1000 series is a 1000W AC/DC power supply with PFC function, designed for high reliability and suitable for multiple industries. Key features include: compact size (230\*127\*41 mm) for better space utilization in system installations, ultra-wide input range of 85~305Vac for global compatibility, up to 94% efficiency for energy-saving and carbon reduction, programm-able output voltage (0~120%) and current (0~100%), constant current design with 200% peak power capability, parallel output capacity up to 4000W, wide operating temperature range from -40 to +85°C (+60°C at full load), compliance with OVCIII, built-in Remote Control /Remote Sense/DC OK signal/auxiliary power, internal PCB coating, complete protections, certifications for multiple safety standards including 62368-1, 60601-1, 61558-1, 60335-1, 62477-1, and 61010-1, as well as 2 X MOPP compliance and extremely low leakage current (<350µA). It is suitable for BF-rated medical equipment and comes with a 5-years warranty, making it a highly cost-effective solution for industrial power supply needs.

**Model Encoding**

NSP - 1000 - 48 MOD

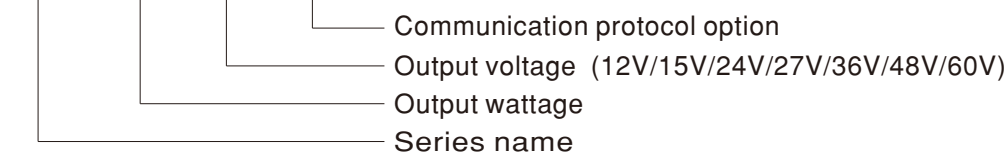

Type	Communication Protocol	Note
Blank	CANBus protocol	In Stock
MOD	MODBus protocol	By request



# 1000W AC/DC High Reliable Multi-Industrial Enclosed Type Power Supply **NSP-1000** series

SPECIFICATION		NSP-1000-12	NSP-1000-15	NSP-1000-24	NSP-1000-27	NSP-1000-36	NSP-1000-48	NSP-1000-60
		□ =Blank (standard model in stock), MOD (By request model)						
<b>OUTPUT</b>								
DC VOLTAGE		12V	15V	24V	27V	36V	48V	60V
CURRENT		83.4A	66.7A	41.7A	37A	27.8A	21A	16.8A
CURRENT RANGE		0 ~ 83.4A	0 ~ 66.7A	0 ~ 41.7A	0 ~ 37A	0 ~ 27.8A	0 ~ 21A	0 ~ 16.8A
RATED POWER		1000.8W	1000.5W	1000.8W	999W	1000.8W	1008W	1008W
PEAK	CURRENT(5 sec.)	166.7A	133.4A	83.4A	64A	55.6A	41.7A	33.4A
	POWER(5 sec.)	2000W	2000W	2000W	2000W	2000W	2000W	2000W
RIPPLE & NOISE (max.) Note.3		150mVp-p	150mVp-p	200mVp-p	200mVp-p	300mVp-p	300mVp-p	450mVp-p
VOLTAGE ADJ. RANGE		10.8 ~ 14.4V	13.5 ~ 19V	21.6 ~ 28.8V	24.3 ~ 32.4V	32.4 ~ 43.2V	43.2 ~ 55V	54 ~ 72V
VOLTAGE TOLERANCE Note.4		± 1.0%						
LINE REGULATION		± 0.5%						
LOAD REGULATION		± 0.5%						
SETUP, RISE TIME Note.5		2500ms, 80ms/115Vac		1500ms, 80ms/230Vac		1500ms, 80ms/277Vac		
HOLD UP TIME (Typ.)		12ms @ 70% load, 8ms @full load						
<b>INPUT</b>								
VOLTAGE RANGE		85 ~ 305Vac 120 ~ 431Vdc						
FREQUENCY RANGE		47 ~ 63Hz						
POWER FACTOR (Typ.)		0.98/115Vac; 0.95/230Vac; 0.92/277Vac at full load						
EFFICIENCY (Typ.)		92%	93%	93.5%	93%	93.5%	94%	94%
AC CURRENT (Typ.)		12A/115Vac 6A/230Vac 5A/277Vac						
INRUSH CURRENT (Typ.)		COLD START 25A/115Vac 40A/230Vac 50A/277Vac						
LEAKAGE CURRENT		Earth leakage current <350µA(rms)@277Vac touch current<100µA(rms) @ 277Vac						
<b>PROTECTION</b>								
SHORT CIRCUIT		In Peak Load Mode, Constant current limiting for more than 5 seconds then shut down o/p voltage, re-power on to cover. Please refer to the Function Manual.						
OVERLOAD		In Current Limiting Mode, Constant current limiting, recovers automatically after fault condition is removed. Please refer to the Function Manual.						
OVER VOLTAGE		15 ~ 19V	20 ~ 25V	29 ~ 37V	33~ 42V	44 ~ 54V	56~ 63V	73 ~ 86V
OVER TEMPERATURE		Protection type : Shut down and latch off output voltage, re-power on to recover						
FUNCTION		Protection type : Shut down output voltage, recovers automatically after temperature goes down						
OUTPUT CURRENT PROGRAMMABLE(PC)		Adjustment of constant current level is allowable between 0 ~ 100% of rated current. Please refer to the Function Manual.						
OUTPUT VOLTAGE PROGRAMMABLE(PV)		Adjustment of output voltage is allowable to 0 ~ 120% of nominal output voltage. Please refer to the Function Manual.						
PARALLEL		Up to 4000W or (3+1) units. Please refer to the Function Manual.						
AUXILIARY POWER		5Vaux @ 0.2A Tolerance ±15% , ripple 150mVp-p 12Vaux @ 0.8A Tolerance ±15% , ripple 450mVp-p						
REMOTE CONTROL		By electrical signal or dry contact Power ON: RC short Power OFF: RC open.						
REMOTE SENSE		Compensate voltage drop on the load wiring up to 0.5Vdc						
DC OK SIGNAL		Contact rating(max.):5Vdc/10mA resistive load						
CANBus or MODBus INTERFACE(By request)		Communication provides functions such as control, setting and monitoring						
FAN SPEED CONTROL Note.6		Built-in intelligent fan speed control detect by PSU'S internal temperature						
		10% load with Ta=25℃	30dB					
		70% load with Ta=25℃	45dB					
<b>ENVIRONMENT</b>								
WORKING TEMP.		-40 ~ +85℃ (Refer to "Derating Curve")						
WORKING HUMIDITY		20 ~ 90% RH non-condensing						
STORAGE TEMP., HUMIDITY		-40 ~ +85℃, 10 ~ 95% RH non-condensing						
TEMP. COEFFICIENT		± 0.03%/℃ (0 ~ 60℃)						
VIBRATION		10 ~ 500Hz, 2G 10min./1cycle, 60min. each along X, Y, Z axes						



# 1000W AC/DC High Reliable Multi-Industrial Enclosed Type Power Supply **NSP-1000** series

SAFETY & EMC (Note 6)			
<b>SAFETY STANDARDS</b>	CB IEC62368-1, IEC60335-1, IEC61558-1/-2-16, IEC61010-1/-2-201, IEC60601-1; IEC62477-1 DEKRA BS EN/EN62368-1, BS EN/EN60335-1, BS EN/EN61558-1/-2-16, BS EN/EN61010-1/-2-201, BS EN/EN60601-1(3.2 Version);BS EN/EN62477-1 UL UL62368-1, ANSI/AAMI ES60601-1(3.2 Version),UL61010-1/-2-201 CCC GB4943.1 BSMI CNS15598-1 EAC TP TC 004 SEMI F47 approved; KC/BIS <b>KC 62368-1 and BIS IS 13252(Part 1) certified, no stock by request, contact sales for inquires</b>		
<b>ISOLATION RESISTANCE</b>	Primary-Secondary: <b>2xMOPP</b> , Primary-Earth: 1xMOPP, <b>Secondary-Earth: 1xMOPP</b>		
<b>OVER VOLTAGE CATEGORY</b>	IEC/EN 61558-1/-2-16 (OVC III, altitude up to 2000M) IEC/EN/UL 62368-1 (OVC II, altitude up to 5000M) IEC/EN 60335-1 (OVC II, altitude up to 5000M) IEC/EN/ANSI/AAMI ES60601-1 (OVC II, altitude up to 4000M) IEC/EN/UL 61010-1/-2-201 (OVC II, altitude up to 5000M) IEC/EN 62477-1 (OVC II, altitude up to 5000M)		
<b>SAFETY EXTRA-LOW VOLTAGE(SELV)</b>	IEC/EN 61558-2-16 (SELV, 12 ~ 60V) IEC/EN 60335-1 (SELV, 12 ~ 36V) IEC/EN/UL 62368-1 (SELV/ES1, 12 ~ 48V)		
<b>WITHSTAND VOLTAGE</b>	I/P-O/P: <b>4KVac</b> I/P-FG: <b>2KVac</b> O/P-FG:1.5KVac		
<b>ISOLATION RESISTANCE</b>	I/P-O/P, I/P-FG, O/P-FG:100M Ohms / 500VDC / 25°C / 70% RH		
<b>EMC EMISSION</b>	<b>Parameter</b>	<b>Standard</b>	<b>Test Level / Note</b>
	Conducted	BS EN/EN55032(CISPR32),CNS 15936,GB/T 9254.1,KS C 9832	Class B
		BS EN/EN55014-1(CISPR14-1)	
		BS EN/EN55011(CISPR11)	Class B
	Radiated	BS EN/EN55032(CISPR32),CNS 15936,GB/T 9254.1,KS C 9832	Class B
		BS EN/EN55014-1(CISPR14-1)	
		BS EN/EN55011(CISPR11)	Class B
Harmonic Current	BS EN/EN61000-3-2(IEC61000-3-2)	Class A	
Voltage Flicker	BS EN/EN61000-3-3(IEC61000-3-3)	-----	
<b>EMC IMMUNITY</b>	BS EN/EN55035(CISPR35),BS EN/EN61000-6-2(IEC61000-6-2),BS EN/EN60601-1-2(IEC60601-1-2), BS EN/EN55014-2(CISPR14-2),KS C 9835,SEMI F47 tested at 200Vac		
	<b>Parameter</b>	<b>Standard</b>	<b>Test Level / Note</b>
	ESD	BS EN/EN61000-4-2	Level 4, <b>15KV</b> air ; Level 4, <b>8KV</b> contact
	Radiated	BS EN/EN61000-4-3	Level 3, 10V/m(80MHz~2.7GHz) Table 9, 9~28V/m(385MHz~5.78GHz)
	EFT / Burst	BS EN/EN61000-4-4	Level 3, 2KV
	Surge	BS EN/EN61000-4-5	Level 4, 2KV/Line-Line 4KV/Line-Earth
	Conducted	BS EN/EN61000-4-6	Level 3, 10V
	Magnetic Field	BS EN/EN61000-4-8	Level 4, 30A/m
Voltage Dips and Interruptions	BS EN/EN61000-4-11	>95% dip 0.5 periods, 30% dip 25 periods, >95% interruptions 250 periods	
<b>OTHERS</b>			
<b>MTBF</b>	910.8K hrs min. Telcordia SR-332 (Bellcore) ; 87.5K hrs min. MIL-HDBK-217F (25°C)		
<b>DIMENSION (L*W*H)</b>	<b>230*127*41mm</b>		
<b>PACKING</b>	1.4Kg;9pcs/12.6Kg/0.85CUFT		
<b>NOTE</b>			
1. All parameters NOT specially mentioned are measured at 230Vac input, rated load and 25°C of ambient temperature. 2. Derating may be need under low input voltages. Please refer to "STATIC CHARACTERISTIC" sections for details. 3. Ripple & noise are measured at 20MHz of bandwidth by using a 12" twisted pair-wire terminated with a 0.1uF & 47uF parallel capacitor. 4. Tolerance: includes set up tolerance, line regulation and load regulation. 5. Length of set up time is measured at first cold start. Turning ON/OFF the driver may lead to increase of the set up time. 6. FAN noise test set up according to ISO-7779. 7. The Regulatory Compliance Mark (RCM) is applied on a voluntary basis. The equipment meets the relevant IEC or AS/NZS standards, or AS/NZS 3820 where applicable. The use of the RCM mark complies with AS/NZS 4417.1. 8. The power supply is considered a component which will be installed into a final equipment. All the EMC tests are been executed by mounting the unit on a 720mm*360mm metal plate with 1mm of thickness. The final equipment must be re-confirmed that it still meets EMC directives. For guidance on how to perform these EMC tests, please refer to "EMI testing of component power supplies." (as available on <a href="https://www.meanwell.com/Upload/PDF/EMI_statement_en.pdf">https://www.meanwell.com/Upload/PDF/EMI_statement_en.pdf</a> ) 9. Some factory or model may not have the BIS logo, please contact your MEAN WELL sales for more information. 10. MOPP is suitable for 100-240Vac input only 11. The ambient temperature derating of 3.5°C/1000m with fanless models and 5°C/1000m with fan models for operating altitude higher than 2000m(6500ft). 12. If use PV signal to adjust Vo, under certain operation conditions, ripple noise of Vo might go over rating defined in this specification. ※ Product Liability Disclaimer : For detailed information, please refer to <a href="https://www.meanwell.com/serviceDisclaimer.aspx">https://www.meanwell.com/serviceDisclaimer.aspx</a>			

PFC fosc : 65KHz  
PWM fosc : 85KHz

## Block Diagram

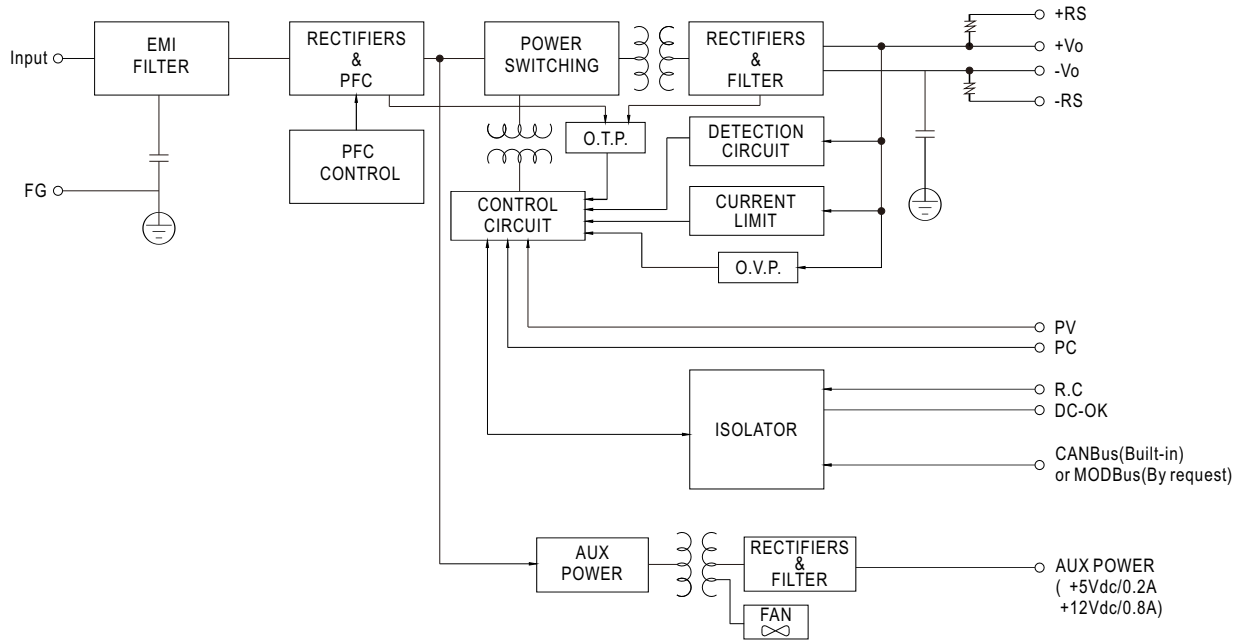

## Derating Curve

Suitable for 100/110/115/120Vac System (85~135Vac)

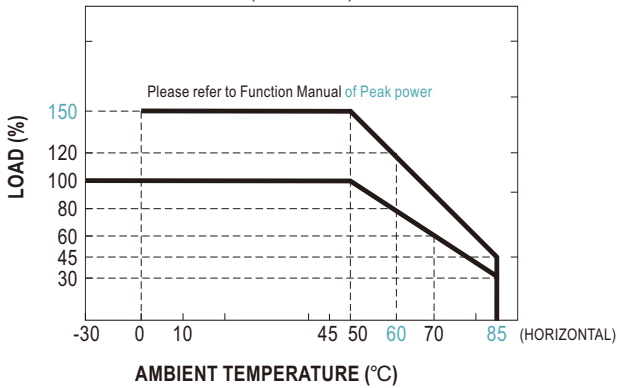

Suitable for 220/230/240/277Vac System (180~305Vac)

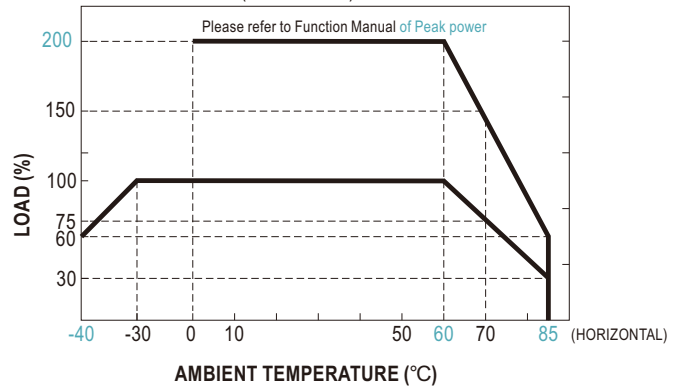

## Output Derating vs Input Voltage

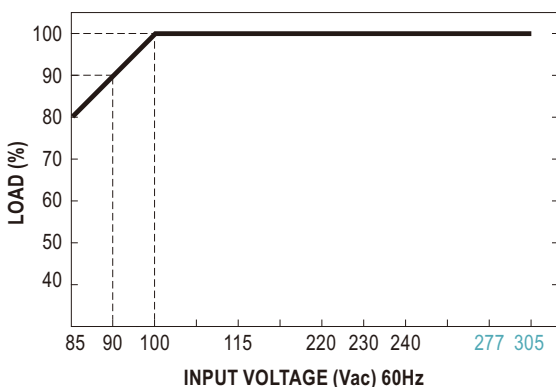

■ **Function Manual**

**1. Peak Power**

$$P_{av} = \frac{P_{pk} \times t + P_{npk} \times (T-t)}{T} \leq P_{rated}$$

$$Duty = \frac{t}{T} \times 100\% \leq 35\%$$

$$t \leq 5 \text{ sec}$$

$P_{av}$  : Average output power (W)

$P_{pk}$  : Peak output power (W)

$P_{npk}$  : Non-peak output power(W)

$P_{rated}$  : Rated output power(W)

$t$  : Peak power width(sec)

$T$  : Period(sec)

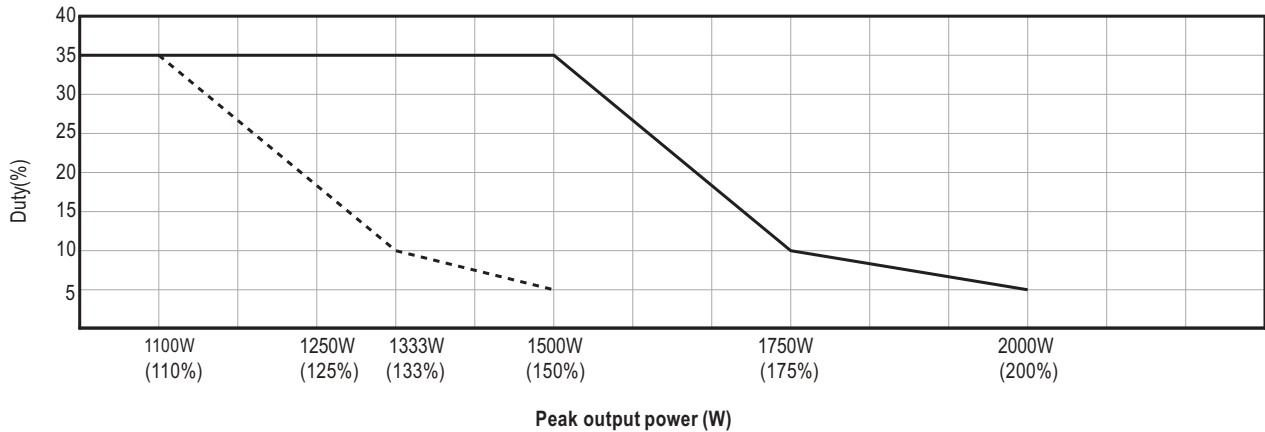
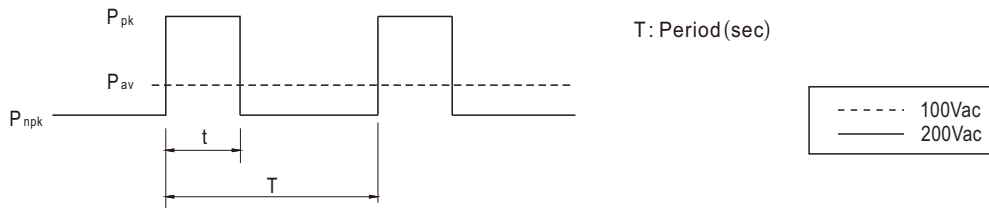

**For example (24V model)**

$V_{in}=220Vac$ , Duty\_max=5%

$P_{av}=P_{rated}=1000W$

$P_{pk}=2000W$



$t \leq 5sec$

$$T \geq \frac{5sec}{5\%} = 100sec$$

$$P_{npk} \leq \frac{TP_{av} - tP_{pk}}{T-t} = 947.4W$$



Note: When the output voltage is adjusted to the upper limit, the peak power is 150% of rated power

## 2. Output Voltage Programming (P.V)

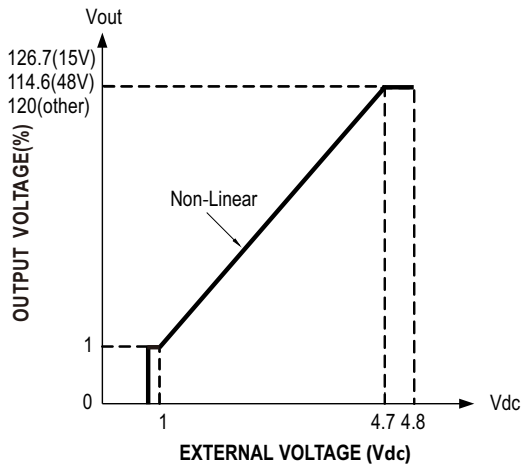
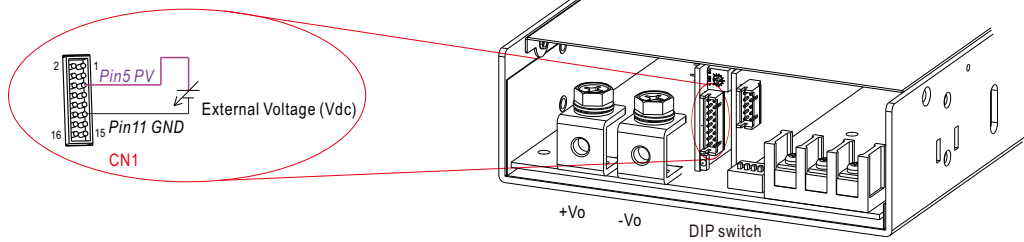
- (1) Default by potentiometer (SVR)
  - (a) Have the DIP switch position-3 set as 
  - (b) Output voltage can be trimmed by SVR.
- (2) By Output Voltage Programming
  - (a) Have the DIP switch position-3 set as 
  - (b) The output voltage can be trimmed to 0~120% by applying EXTERNAL VOLTAGE between PV and GND on CN1.



## 3. Output Current Programming (P.C)

- (1) Default Overload Protection (OLP) value
  - (a) Have the DIP switch position-2 set as 
  - (b) Output current is set default value.
- (2) By Constant Current Level Programming
  - (a) Have the DIP switch position-2 set as 
  - (b) The constant current level can be trimmed to 0~100% of the rated current by applying EXTERNAL VOLTAGE between PC and GND on CN1.

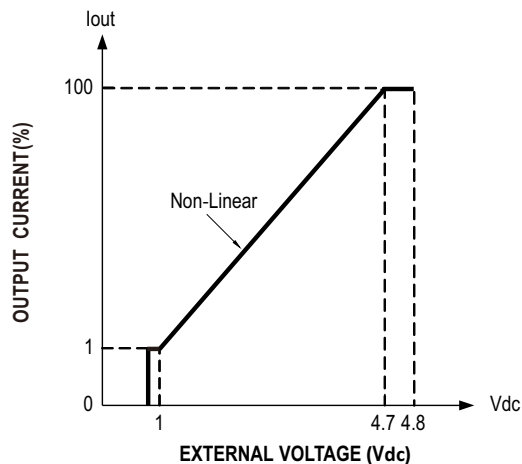
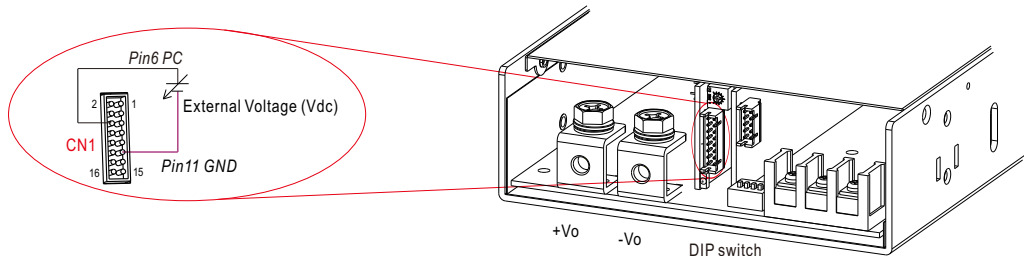

## 4. Remote Control

※ The power supply can be turned ON/OFF individually or along with other units by using the "Remote Control" function with external switch, photocoupler or relay.

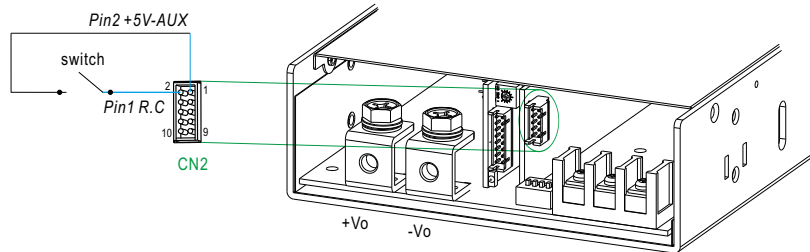

PSU Vo Status	Between +5V-AUX(Pin 2) and R.C(Pin 1)
Power ON	Switch Short
Power OFF	Switch Open

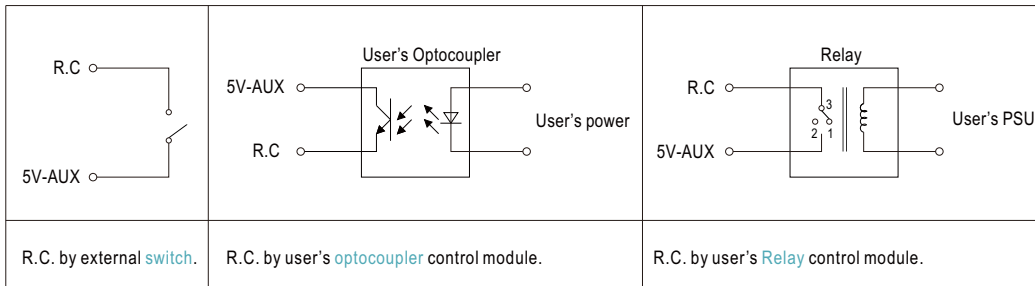

## 5. Remote Sense

※ The Remote Sense compensates voltage drop on the load wiring up to 0.5Vdc

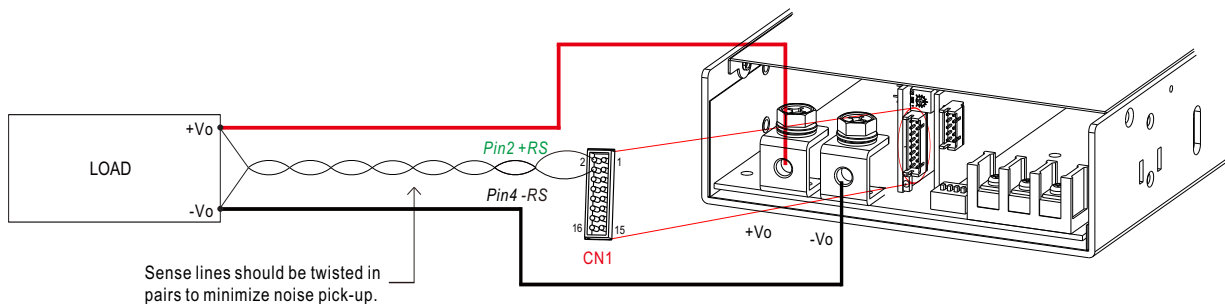

◎ The +RS signal should be connected to the positive terminal of the load whereas -RS signal to the negative terminal.

### 6. Local Sense

※ The +RS,-RS have to be connected to the +Vo(signal), -Vo(signal), respectively, as the following diagram, in order to get the correct output voltage if Remote Sense is not used.

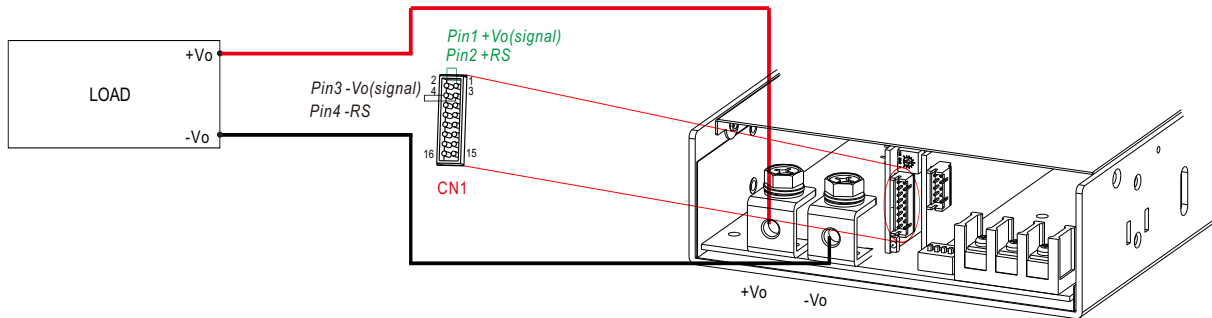

### 7. Paralled Use

NSP-1000 has the built-in active current sharing function and can be connected in parallel, up to 4 units, to provide higher output power as exhibited below :

- ※ The power supplies should be paralleled using short and large diameter wiring and then connected to the load.
- ※ Difference of output voltages among parallel units should be less than 0.2Vdc.
- ※ The total output current must not exceed the value determined by the following equation:  

$$\text{Maximum output current at parallel operation} = (\text{Rated current per unit}) \times (\text{Number of unit}) \times 0.9$$
- ※ Under parallel operation, the minimum output load should be greater than 5% of total output load; otherwise, it is likely that only one unit operates whereas other units may enter standby mode or their LED status indicators may not turn on.
- ※ When the total output current is less than 5% of the total rated current, or say  $(5\% \text{ of Rated current per unit}) \times (\text{Number of unit})$  the current shared among units may not be fully balanced.
- ※ CN1/DIP SW1 Function pin connection

Parallel	PSU1		PSU2		PSU3		PSU4	
	CN1	SW1 POS4	CN1	SW1 POS4	CN1	SW1 POS4	CN1	SW1 POS4
1 unit	X	ON	—	—	—	—	—	—
2 unit	V	ON	V	ON	—	—	—	—
3 unit	V	ON	V	—	V	ON	—	—
4 unit	V	ON	V	—	V	—	V	ON

◎V is CN1 connected to plug pin, X is CN1 not connected to plug pin.



## ■ Mechanical Specification

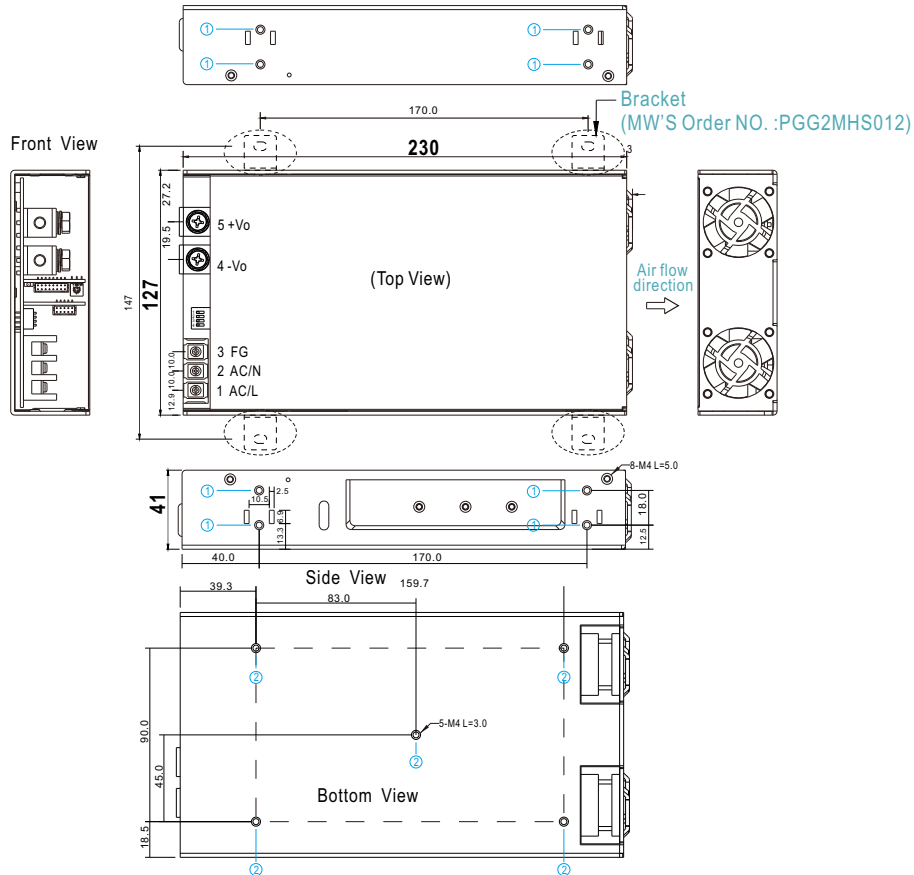

### ※AC Input Terminal Pin No. Assignment

Pin No.	Assignment	Diagram	Screw thread	Mounting torque
1	AC/L or DC input +Vin		M3.5	8~10Kgf.cm
2	AC/N or DC input -Vin			
3	FG $\perp$			

### ※DC Output Terminal Pin No. Assignment

Pin No.	Assignment	Diagram	Screw thread	Mounting torque
4	-Vo		M5	10~12Kgf.cm
5	+Vo			

### ※ Mounting Instruction

Hole No.	Recommended Screw Size	MAX. Penetration Depth L	Mounting torque
①	M4	5mm	8~10Kgf.cm
②	M4	3mm	8~10Kgf.cm

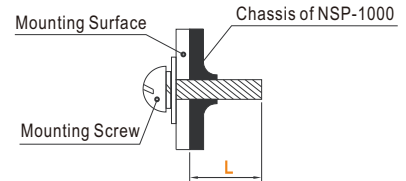

### ※Control Pin No. Assignment (CN1) : HRS DF11-16DP-2DS or equivalent

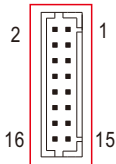

Mating Housing	JS-2008R-08X2 or equivalent
Terminal	JS-2007-08X2 or equivalent

Pin No.	Function	Description
1	+Vo (Signal)	Positive output voltage signal. It is for local sense; it cannot be connected directly to the load.
2	+RS	Positive sensing for remote sense.
3	-Vo (Signal)	Negative output voltage signal. It is for local sense and certain function reference; it cannot be connected directly to the load.
4	-RS	Negative sensing for remote sense.
5	PV	Connection for output voltage programming. (Note.1)
6	PC	Connection for constant current level programming. (Note.1)
7,8,9,10	A0,A1,A2,A3	Interface address lines. (Note.2)
11,12	GND	These pins connect to the negative terminal for signals.
13,14	DA	Differential digital signal for parallel control.
15,16	DB	Differential digital signal for parallel control.

Note1: Non-isolated signal, referenced to [GND].

Note2: Interface address setting, please refer to the user manual for more details.

※ Control Pin No. Assignment(CN2) : HRS DF11-10DP-2DS or equivalent

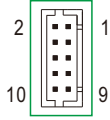

Mating Housing	JS-2008R-05X2 or equivalent
Terminal	JS-2007-05X2 or equivalent

Pin No.	Function	Description
1	R.C	The unit can turn the output ON/OFF by electrical signal or dry contact between R.C and +5V-AUX. (Note) Short (4.5 ~ 5.5Vdc) : Power ON ; Open (-0.5 ~ 0.5Vdc) : Power OFF ; The maximum input voltage is 5.5Vdc.
2	+5V-AUX	Auxiliary voltage output, 4.25~5.75Vdc, referenced to GND-AUX (pin2). The maximum load current is 0.2A. This output has the built-in "Oring diodes" and is not controlled by "R.C"
3	DC-OK	High (3.5 ~ 5.5Vdc) : When the $V_{out} \leq 77\% \pm 5\%$ . Low (-0.5 ~ 0.5Vdc) : When $V_{out} \geq 80\% \pm 5\%$ . The maximum sourcing current is 10mA and only for output. (Note)
4,6	GND-AUX	Auxiliary voltage output GND. The signal return is isolated from the output terminals (+V & -V).
5	+12V-AUX	Auxiliary voltage output, 10.2~13.8Vdc, referenced to GND-AUX (pin2). The maximum load current is 0.8A. This output has the built-in "Oring diodes" and is not controlled by "R.C".
7	D+	For MODBus model: Data line used in MODBus interface. (Note)
	CANH	For CANBus model: Data line used in CANBus interface. (Note)
8	D-	For MODBus model: Data line used in MODBus interface. (Note)
	CANL	For CANBus model: Data line used in CANBus interface. (Note)
9	RTA	120 $\Omega$ termination resistor for CANBus/MODBus
10	RTB	120 $\Omega$ termination resistor for CANBus/MODBus

Note: Isolated signal, referenced to GND-AUX.

※ DIP Switch Position Assignment(DIP-SW1): Please refer to the Function Manual.

Pin No.	Assignment	Diagram
1	Overload protection mode configuration	
2	Output Current Programming (PC)	
3	Output Voltage Programming (PV)	
4	Termination resistor for current sharing bus	

DIP-SW POS1: OLP\_MODE  
DIP-SW POS2: PC  
DIP-SW POS3: PV  
DIP-SW POS4: RT

※ LED Status Indicators

Description	Output of alarm
Normal operation	Green : Steadily lit
Remote off	Red : Steadily lit
Internal over-temperature	Orange : 1 Blink/Pause
Overload/Short	Red : 1 Blink/Pause
Over voltage	Red : 2 Blink/Pause
Over temperature	Red : 3 Blink/Pause
Fan fail	Red : 4 Blink/Pause
AC under voltage	Red : 5 Blink/Pause
Others (Note)	Red : 6 Blink/Pause

Note: 1. Others include hardware fault etc.

2. In PC mode, both OLP and SCP operate in constant current limiting, with the indicator steadily lit green.

■ Accessory List

No.	Item	Quantity
1	Control function interface(CN1) mating wire along with NSP-1000 (standard accessory)	1pcs/per model
2	Control function interface(CN2) mating wire along with NSP-1000 (standard accessory)	1pcs/per model
3	Control function interface(CN2) mating wire along with NSP-1000 (standard accessory)	1pcs/per model
4	Control function interface(CN1) mating wire along with NSP-1000 (standard accessory)	1pcs/per model
5	Bracket MW'S Order NO. :PGG2MHS012 (By request accessory, should ordered seperately)	4pcs/per model (Please refer to Installation Diagram)
6	Terminal cover MW'S Order NO. :PEE4TBC-03 (By request accessory, should ordered seperately)	1pcs/per model



■ Installation Diagram

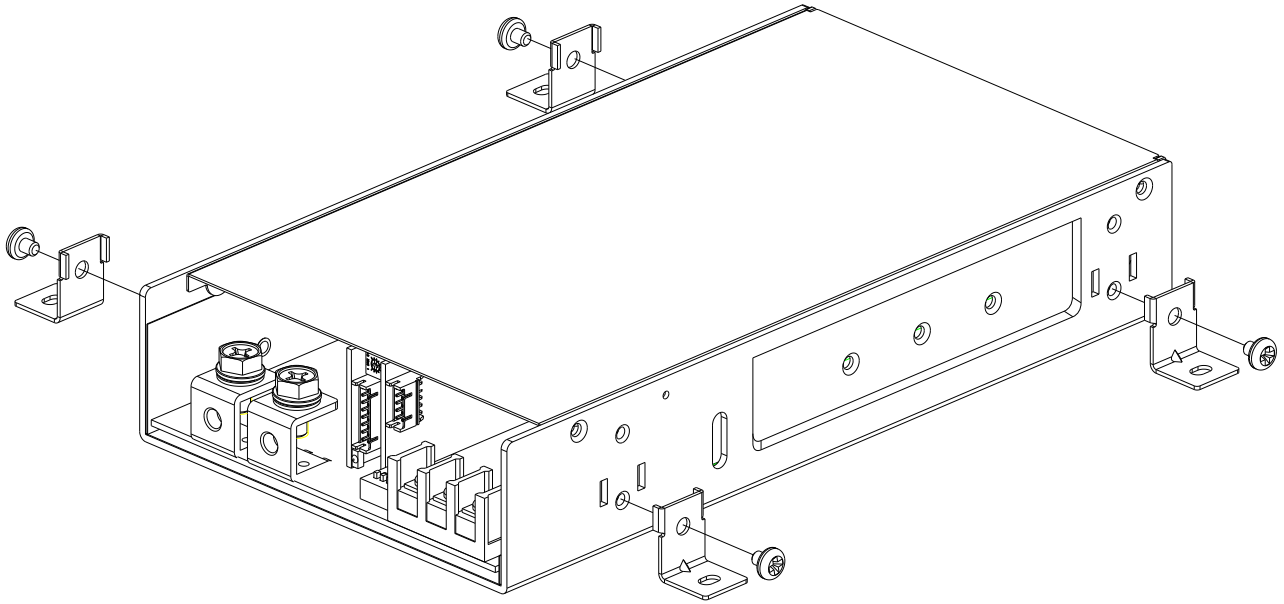

■ Installation Manual

Please refer to : <http://www.meanwell.com/manual.html>