



# **PHP-3500**

## **User's Manual**

<b>0. Safety Guidelines</b> .....	1
<b>1. Introduction</b> .....	1
1.1 Introduction .....	1
1.2 Features .....	1
1.3 Order Information .....	1
1.4 Main Specification .....	2
<b>2. Mechanical Specification and Input/Output Terminals</b> .....	3
2.1 Mechanism .....	3
<b>3. Functions</b> .....	4
3.1 Input Voltage Range .....	4
3.2 Inrush Current Limiting .....	4
3.3 Rated Power .....	4
3.4 Power Factor Correction (PFC) .....	4
3.5 Output Voltage/Current Adjustment .....	5
3.6 Short-Circuit and Over-Current Protection .....	6
3.7 Over-Voltage Protection .....	6
3.8 Over-Temperature Protection and Alarm .....	6
3.9 DC OK Signal .....	6
3.10 Remote Control .....	6
3.11 Parallel Operation .....	6
3.12 Auxiliary Power .....	7
3.13 Factory Resetting .....	7
<b>4. Communication Protocol</b> .....	7
4.1 PMBus Addressing and CAN ID setting .....	7
4.2 PMBus Command List .....	8
4.3 CANBus Communication Interface .....	13
<b>5. Notes on Operation</b> .....	21
5.1 Installation Method .....	21
5.2 Derating .....	21
5.3 Water Cooling System .....	22
5.4 Warranty .....	22



# PHP- 3500 User's Manual

## 0.Safety Guidelines

- ⊙ Risk of electrical shock and hazard, all failure should be examined by a qualified technician. Please do not remove the case from the supply by yourself.
- ⊙ Please do not change any component on the unit or make any kind of modification on it.
- ⊙ Please do not install the unit in places with high ambient temperature or under direct sunlight.
- ⊙ The input voltage range is 100-240Vac(50/60Hz), please do not feed in voltage that is over or less than 10% of that range.

## 1.Introduction

### 1.1 Introduction

PHP series is a water-cooled power supply designed to provide energy for laser processing equipment, wide band power amplifier, broadcast systems and acoustic noise sensitive systems.

### 1.2 Feature Description

- ⊙ Universal AC input/Full range.
- ⊙ Built-in active PFC function, PF>0.95.
- ⊙ Protection: Short circuit/ Overload/ Over voltage/ Over temperature.
- ⊙ Built-in remote ON-OFF control
- ⊙ Output voltage programming.
- ⊙ Output current programming.
- ⊙ 12V/0.5A auxiliary output.
- ⊙ PMBus serial data transmission function.
- ⊙ 5 years warranty.

### 1.3 Order Information

#### 1.3.1 Explanation for Encoding



#### 1.3.2 Marking

- ⊙ Please refer to the safety label sticker on the top of the unit before use (Figure 1-1).

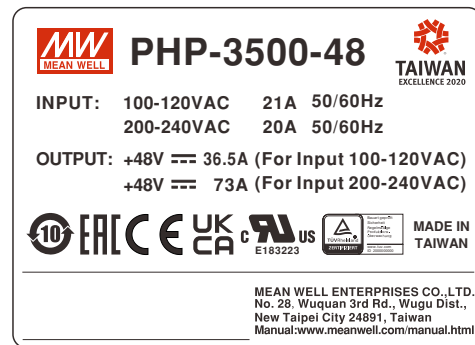
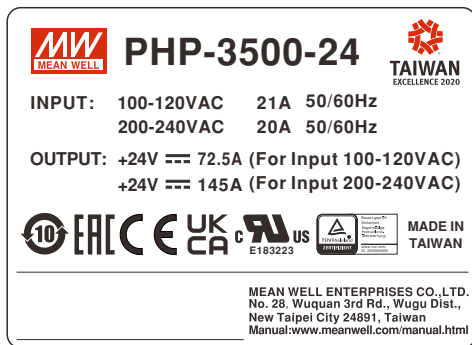

Figure 1-1 PHP-3500 Safety label sticker

### 1.4 Main Specification

MODEL		PHP-3500-24	PHP-3500-48	
OUTPUT	DC VOLTAGE	24V	48V	
	RATED CURRENT	145A	73A	
	RATED POWER	3480W	3504W	
	RIPPLE & NOISE (max.) Note.2	300mVp-p	480mVp-p	
	VOLTAGE ADJ. RANGE	By built-in potentiometer, SVR		
		24~28.8V	48~57.6V	
	VOLTAGE TOLERANCE Note.3	±1.0%	±1.0%	
	LINE REGULATION	±0.5%	±0.5%	
	LOAD REGULATION	±0.5%	±0.5%	
	SETUP, RISE TIME Note.4	1500ms, 60ms/230VAC 1500ms, 60ms/115VAC at full load		
HOLD UP TIME (Typ.) Note.4	16ms/230VAC at 75% load 10ms/230VAC at full load ; 16ms/115VAC at 75% load 10ms/115VAC at full load			
INPUT	VOLTAGE RANGE Note.4	90 ~ 264VAC 127 ~ 370VDC		
	FREQUENCY RANGE	47 ~ 63Hz		
	POWER FACTOR (Typ.) Note.4	PF ≥ 0.95/230VAC PF ≥ 0.99/115VAC at full load		
	EFFICIENCY (Typ.) Note.10	95%	96%	
	AC CURRENT (Typ.)	20A/115VAC 20A/230VAC		
	INRUSH CURRENT (Typ.)	Cold start 30A/115VAC 80A/230VAC		
LEAKAGE CURRENT	2mA / 240VAC			
PROTECTION	OVERLOAD	105 ~ 115% rated current Protection type : Constant current limiting, shut down O/P voltage after 5 sec. After O/P voltage falls, re-power on to recover		
	OVER VOLTAGE	30 ~ 36V	60 ~ 72V	
		Protection type : Shut down O/P voltage, re-power on to recover		
OVER TEMPERATURE	Protection type : Shut down O/P voltage, recovers automatically after temperature goes down			
FUNCTION	OUTPUT VOLTAGE PROGRAMMABLE(PV) Note.5,6	Adjustment of output voltage is allowable to 50 ~ 120% of nominal output voltage. Please refer to the Function Manual.		
	OUTPUT CURRENT PROGRAMMABLE(PC) Note.6	Adjustment of constant current level is allowable to 20 ~ 100% of rated current. Please refer to the Function Manual.		
	REMOTE ON/OFF CONTROL	Power ON : Short circuit Power OFF : Open circuit		
	AUXILIARY POWER	12V@0.5A tolerance ±10%, ripple 150mVp-p		
	DC-OK SIGNAL	The TTL signal out, PSU turn on = -0.5 ~ 0.5V ; PSU turn off = 3.5 ~ 5.5V. Please refer to the Function Manual.		
ENVIRONMENT	WORKING TEMP.	-30 ~ +70°C Baseplate temperature (Refer to "Derating Curve")		
	WORKING HUMIDITY	20 ~ 90% RH non-condensing		
	STORAGE TEMP., HUMIDITY	-40 ~ +85°C, 10 ~ 95% RH non-condensing		
	TEMP. COEFFICIENT	±0.03%/°C (0 ~ 50°C)		
	VIBRATION	10 ~ 500Hz, 2G 10min./1cycle, 60min. each along X, Y, Z axes		
OVER VOLTAGE CATEGORY	II ; According to EN61558; altitude up to 5000 meters.			
SAFETY & EMC (Note.8)	SAFETY STANDARDS	UL62368-1, CAN/CSA C22.2 No. 62368-1, TUV BS EN/EN62368-1, EAC TP TC 004 approved ; design refers to BS EN/EN61558-1, BS EN/EN60335-1		
	WITHSTAND VOLTAGE	I/P-O/P:3KVAC I/P-FG:2KVAC O/P-FG:1.25KVAC		
	ISOLATION RESISTANCE	I/P-O/P, I/P-FG,O/P-FG:100M Ohms/500VDC/25°C / 70%RH		
	EMC EMISSION	Parameter	Standard	Test Level / Note
		Conducted	BS EN/EN55032 (CISPR32)	Class A
		Radiated	BS EN/EN55032 (CISPR32)	Class A
		Harmonic Current	BS EN/EN61000-3-12	-----
	EMC IMMUNITY	BS EN/EN55035		
		Parameter	Standard	Test Level / Note
		ESD	BS EN/EN61000-4-2	Level 3, 8KV air ; Level 2, 4KV contact
Radiated		BS EN/EN61000-4-3	Level 3	
EFT / Burst		BS EN/EN61000-4-4	Level 3	
Surge		BS EN/EN61000-6-2	2KV/Line-Line 4KV/Line-Earth	
Conducted		BS EN/EN61000-4-6	Level 3	
Magnetic Field	BS EN/EN61000-4-8	Level 4		
Voltage Dips and Interruptions	BS EN/EN61000-4-11	>95% dip 0.5 periods, 30% dip 25 periods, >95% interruptions 250 periods		
OTHERS	MTBF	544.8K hrs min. Telcordia SR-332 (Bellcore) ; 56.3K hrs min. MIL-HDBK-217F (25°C)		
	DIMENSION	380*141.4*60mm (L*W*H)		
	PACKING	4.5Kg;4pcs/19Kg/2.46CUFT		
NOTE	<p>1. All parameters NOT specially mentioned are measured at 230VAC input, rated load and 25°C of ambient temperature.</p> <p>2. Ripple &amp; noise are measured at 20MHz of bandwidth by using a 12" twisted pair-wire terminated with a 0.1uf &amp; 47uf parallel capacitor.</p> <p>3. Tolerance :includes set up tolerance, line regulation and load regulation.</p> <p>4. Derating may be needed under low input voltages. Please check the derating curve and Static characteristics for more details.</p> <p>5. Without water or fan cooling to provide adequate heat dissipation, OTP might be triggered if trimming output voltage by PV signal toward upper or bottom limits of nominal voltage. Under such condition, enhanced cooling on PSU is highly recommended.</p> <p>6. PV/PC function when users are not operating on PMBus. SVR functions when users are neither operation on PMBus nor using PV/PC.</p> <p>7. Output will shut down after O/P voltage is below &lt; 80% of Vset for 5 sec, re-power on to recover.</p> <p>8. The power supply is considered a component which will be installed into a final equipment. All the EMC tests are been executed by mounting the unit on a 600mm*900mm metal plate with 1mm of thickness. The final equipment must be re-confirmed that it still meets EMC directives. For guidance on how to perform these EMC tests, please refer to "EMI testing of component power supplies." (as available on <a href="https://www.meanwell.com/Upload/PDF/EMI_statement_en.pdf">https://www.meanwell.com/Upload/PDF/EMI_statement_en.pdf</a>)</p> <p>9. The ambient temperature derating of 3.5°C/1000m with fanless models and of 5°C/1000m with fan models for operating altitude higher than 2000m(6500ft).</p> <p>10. The efficiency is measured at 75% load.</p> <p>※ Product Liability Disclaimer : For detailed information, please refer to <a href="https://www.meanwell.com/serviceDisclaimer.aspx">https://www.meanwell.com/serviceDisclaimer.aspx</a></p>			

## 2. Mechanical Specification and Input/Output Terminals

### 2.1 Mechanism

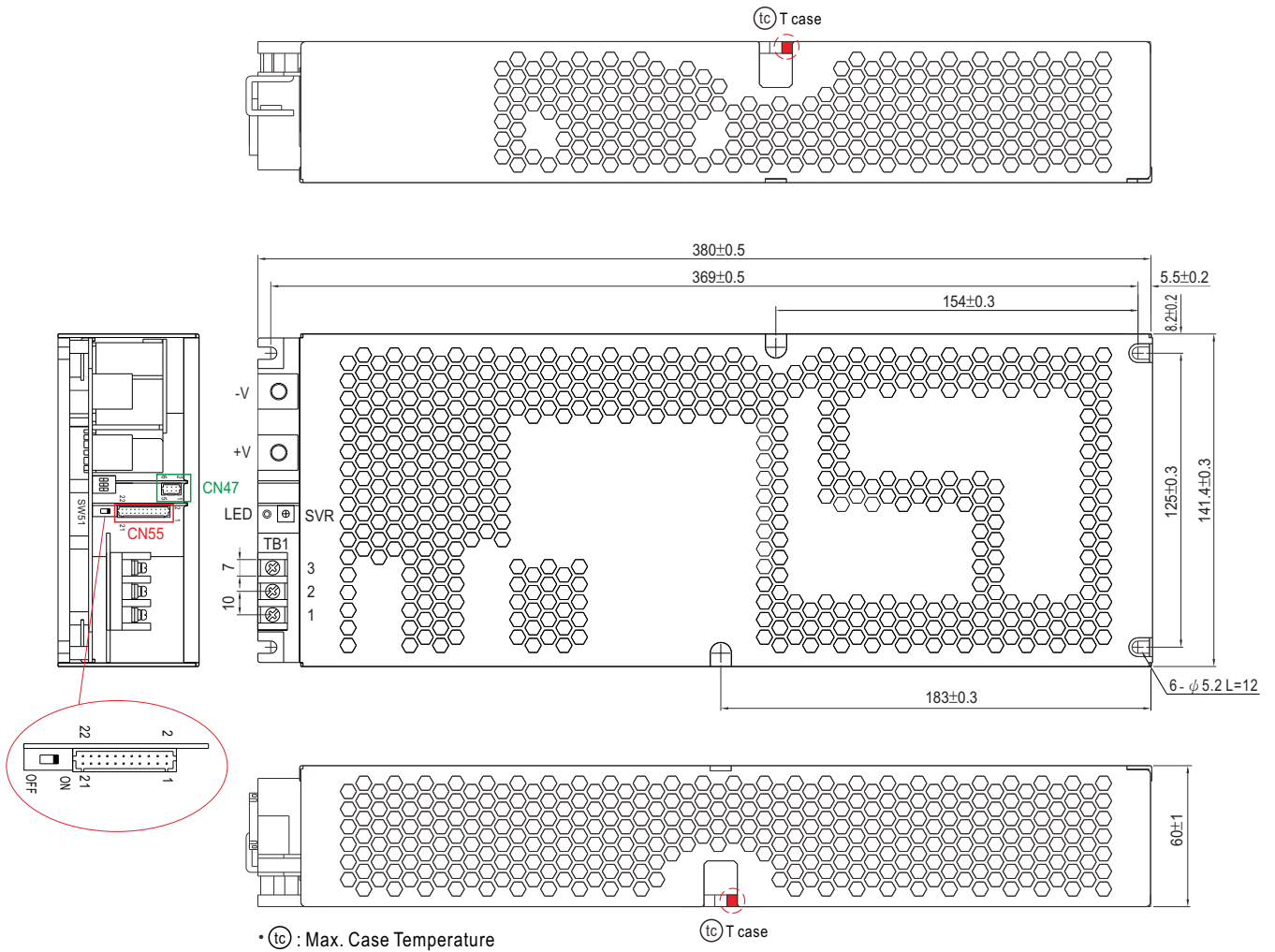
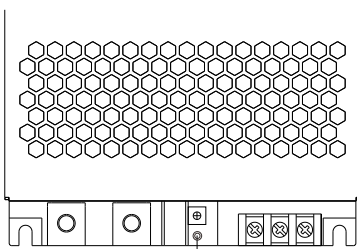

Figure 2-1

#### ※ LED Status Indicators

LED	Description
● Green	The power supply functions normally
● Red (Flashing)	The LED will flash with red light when internal temperature reaches 85°C; under this condition, the unit still operates normally without entering OTP. (In the meantime, an alarm signal will be sent out through the PMBus /CANBus interface.)
● Red	Abnormal status (Over temperature protection, Overload protection, Fan fail.)



LED Status Indicator

Figure 2-2 PHP-3500 terminal illustration

※ Connector Pin No. Assignment (CN55)

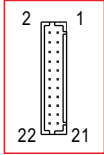

Pin No.	Function	Description
1	-V (Signal)	Negative output voltage signal.
2	+V (Signal)	Positive output voltage signal.
3,4	PC	Connection for constant current level programming. (Note.1)
5,6	PV	Connection for output voltage programming. (Note.1)
7,8,9,10,11,12	NC	-----
13,14,15,16	DB,DA	Differential digital signal for parallel control. (Note.1)
17,18	GND-AUX(S)	The signal return is isolated from the output terminals (+V & -V).
19,20	SCL	For PMBus model: Serial Clock used in the PMBus interface. (Note.2)
	CANL	For CANBus model: Data line used in CANBus interface. (Note.2)
21,22	SDA	For PMBus model: Serial Data used in the PMBus interface. (Note.2)
	CANH	For CANBus model: Data line used in CANBus interface. (Note.2)

Note1: Non-isolated signal, referenced to [-V(signal)].

Note2: Isolated signal, referenced to GND-AUX(S).

※ Connector Pin No. Assignment (CN47)

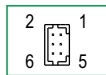

Pin No.	Function	Description
1	+12V-AUX	Auxiliary voltage output, 10.8~13.2V, referenced to GND-AUX (pin 2). The maximum load current is 0.5A. This output has the built-in "Oring diodes" and is not controlled by the Remote ON/OFF control.
2	GND-AUX	Auxiliary voltage output GND. The signal return is isolated from the output terminals (+V & -V).
3	Remote ON-OFF	The unit can turn the output ON/OFF by electrical signal or dry contact between Remote ON/OFF and +12V-AUX. (Note.2) Short (10.8 ~ 13.2V) : Power ON ; Open (-0.5 ~ 0.5V) : Power OFF ; The maximum input voltage is 13.2V.
4	GND-AUX(S)	The signal return is isolated from the output terminals (+V & -V).
5	DC-OK	High (3.5 ~ 5.5V) : When the Vout ≤ 80%±5%. Low (-0.5 ~ 0.5V) : When Vout ≥ 80%±5%. The maximum sourcing current is 4mA and only for output. (Note.2)
6	T-ALARM	High (3.5 ~ 5.5V) : When the internal temperature exceeds the limit of temperature alarm. Low (-0.5 ~ 0.5V) : When the internal temperature is normal, and when fan works normally. The maximum sourcing current is 4mA and only for output(Note.2)

Note1: Non-isolated signal, referenced to [-V(signal)].

Note2: Isolated signal, referenced to GND-AUX(S).

### 3.Functions

#### 3.1 Input Voltage Range

- ◎ The input voltage range is AC90~264V or DC127~370V.
- ◎ To insure proper operation, AC input should be within the pre-specified range. A wrong input will cause the supply unit operating improperly, losing PFC function or even damaging the unit in a worst case scenario.
- ◎ The efficiency will be lower and the output current will be automatically limited to a predetermined safe value if the unit is applied with a lower input voltage. Please refer to 4.2 Derating for more information.

#### 3.2 Inrush Current Limiting

- ◎ Built-in inrush current limiting circuit .
- ◎ If adding an external switch (a relay/ a circuit breaker) at the input side is required, choose switches that are able to withstand inrush current of the unit.
- ◎ Since the inrush current limiting circuit mainly consists of a NTC thermistor and a relay, inrush current will be much higher than the specified value if the input thermistor is not allowed sufficient time to cool down. After turning off the supply, a 10 second cool down period is recommended before turning them on again.

#### 3.3 Output Power

PHP-3500-24 : 3480W (24V / 145A)

PHP-3500-48 : 3504W (48V / 73A)

#### 3.4 Power Factor Correction (PFC)

- ◎ Built-in active power factor correction (PFC) function, power factor (PF) will be 0.95 or better when input voltage is in a range of 90-230Vac and operated at full load condition. PF will be less than 0.95 if the output is not at full load or the input voltage is higher than 230Vac.

### 3.5 Output Voltage/Current Adjustmen

#### 3.5.1 General adjustment

Output voltage can be trimmed by adjusting SVR (on the terminal end), please utilize an insulated cross-head screwdriver to make an adjustment.

#### 3.5.2 Adjustment with an external 0 - 5Vdc source (Output Voltage Programming)

- (1) Connect output of the external DC source to PV (PIN5 or PIN6) and -V (PIN1) on CN55, shown in Figure 3-1.
- (2) Relationship between output voltage and external DC source is shown in Figure 3-2.
- (3) While increasing the output to a higher voltage level, please reduce the load current accordingly. Output wattage of the unit should not exceed the rated value under any circumstances.

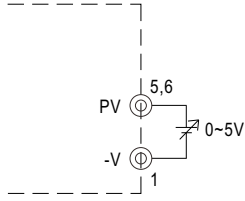
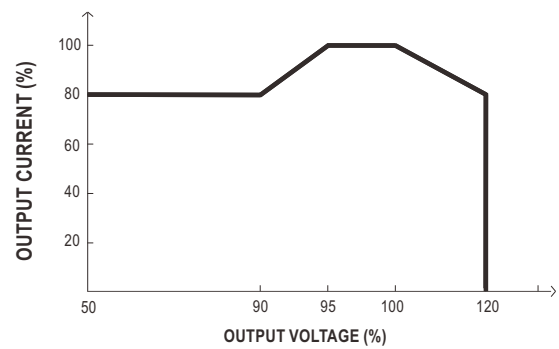
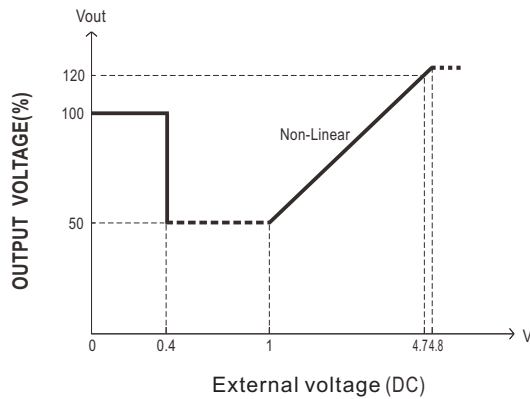

Figure 3-1 Connection of external DC voltage source



Ⓢ The rated current should change with the output voltage programming accordingly.

Figure 3-2

#### 3.5.3 Output current adjustment (Output Current Programming)

※ Constant current level can be adjusted within a range of 20 -100% of the rated current via an external DC source, wiring is shown as below.

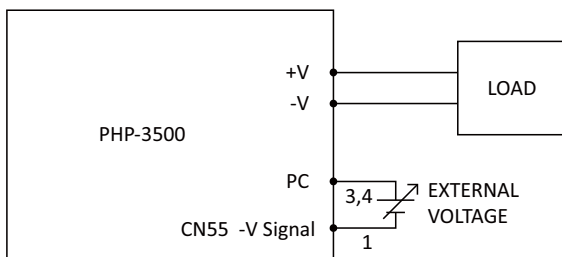

Relationship between output current and external DC source is shown as below.

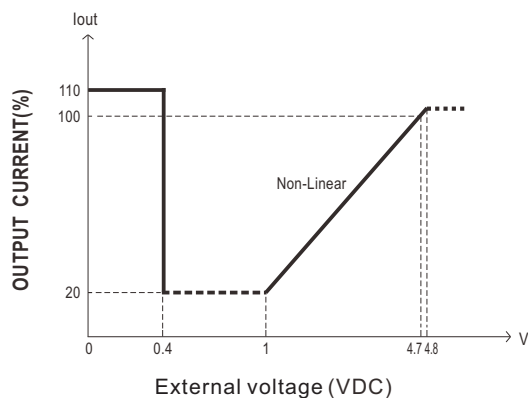

Note: The PHP-3500 will trigger OLP to shut down itself if the output stays at constant current level condition for more than 5 seconds.

### 3.6 Short Circuit Protection & Over Current Protection

- ⊙ The protection activates when the output is short-circuited or the output current exceeds 110%±5 of the rated output current. Re-power on to recover when short-circuit/overload condition is removed.

### 3.7 Over Voltage Protection (OVP)

- ⊙ Built-in over voltage protection circuit.
- ⊙ OVP triggering points vary in different output models. Please refer to the specification sheet for detailed information.
- ⊙ Once OVP is triggered, leave the unit off for 20 seconds before recycling AC again.

### 3.8 Over Temperature Protection (OTP) and Alarm

- ⊙ Built-in thermal detection circuit, once the internal temperature exceeds a threshold value, the unit will shut down automatically. Please switch off the AC input, remove all possible causes and then leave the unit cooling down to a normal working temperature (approximate 10 minutes - 1 hour) before repower on again.
- ⊙ When internal temperature reaches 85°C, trigger point of a thermal alarm, the red LED on the output will flash and there will be an alarm signal sent out through the PMBus/CANBus (by request) interface, please refer to 3.13.2. Even so, the unit is still operating normally.
- ⊙ When the internal temperature is within a normal value, there will be a "LOW" signal (-0.5-0.5V) sent out through T-ALARM on CN47; There will be a "HIGH" signal (3.5-5.5V) sent out through T-ALARM on CN47 when internal temperature exceeds a certain value. (referenced to GND-AUX).
- ⊙ Maximum output current: 10mA

### 3.9 DC OK Signal

- ⊙ Built-in DC output voltage detection circuit.
- ⊙ When DC output voltage is within a normal value, there is a "LOW" signal (-0.5-0.5V) sent out through  $\overline{\text{DC-OK}}$  on CN47. (referenced to GND-AUX).
- ⊙ When DC output voltage is out of normal range, there is a "HIGH" signal (3.5-5.5V) sent out through  $\overline{\text{DC-OK}}$  on CN47. (referenced to GND-AUX).
- ⊙ Maximum output current: 10mA

### 3.10 Remote Control

- ⊙ Built-in remote ON/OFF control circuit, refer to Figure 3-3 for the control method.
- ⊙ Please be aware that "ON/OFF" and "+12V-AUX" on CN47 should be linked together to allow the unit operate normally; If they are kept open, there will be no output voltage.
- ⊙ Maximum input voltage: 13.2V



Figure 3-3 Connection of Remote Control

### 3.11 Parallel Operation

- ⊙ Parallel operation is only suitable for the identical units (with the same model and the same output voltage/current).
- ⊙ The power supplies should be paralleled using short and large diameter wiring and then connected to the load.
- ⊙ The total output current must not exceed the value determined by the following equation: Maximum output current at parallel operation = (Rated current per unit) × (Number of unit) × 0.9.
- ⊙ When the total output current is less than 5% of the total rated current, or say (5% of Rated current per unit) × (Number of unit) the current shared among units may not be balanced.
- ⊙ Under parallel operation ripple of the output voltage may be higher than the SPEC at light load condition, It will go back to normal ripple level once the output load is more than 5%.
- ⊙ CN55/SW51 Function pin connection.

Parallel	PSU1		PSU2		PSU3		PSU4	
	CN55	SW51	CN55	SW51	CN55	SW51	CN55	SW51
1 unit	X	ON	—	—	—	—	—	—
2 unit	V	ON	V	ON	—	—	—	—
3 unit	V	ON	V	OFF	V	ON	—	—
4 unit	V	ON	V	OFF	V	OFF	V	ON

(V : CN55 connected ; X : CN55 not connected.)



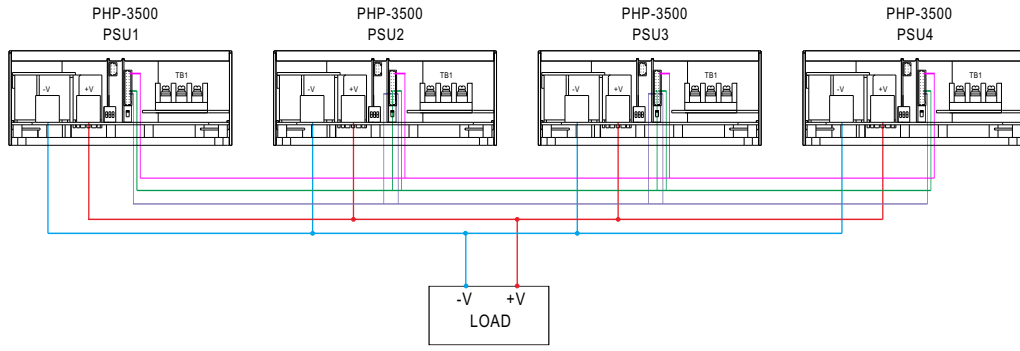
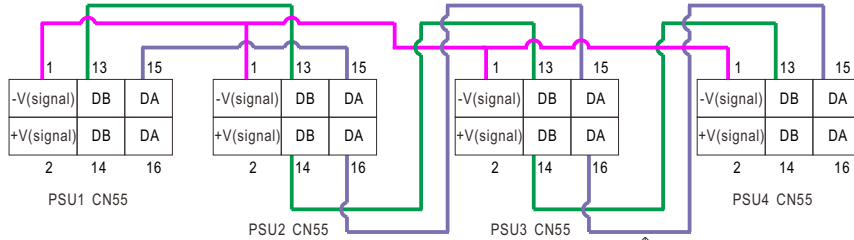

Fig 6.1



If the lines of CN55 are too long, they should be twisted in pairs to avoid noise.

- ⊙ DA, DB and -V(signal) are connected mutually in parallel.

### 3.12 Auxiliary Output

- ⊙ Built-in 12V/0.5A auxiliary output.

### 3.13 Factory Resetting

- ⊙ Users can follow the steps below to restore factory settings for commands : (PMBus: 01h, 22h, 46h, BEh; CANBus: 0x0000 · 0x0020 · 0x0030 · 0x00C2)
  1. Set DIP switch all in the "ON" position.
  2. Turn on the AC without remote on, there should be no voltage at the output.
  3. Within 15 seconds, set DIP switch all in the "OFF" position and all back in the "ON" again.
  4. The green LED flashing 3 times means the process is successfully done.
  5. Restart the supply to load factory settings.

## 4. Communication Protocol

There are two means to control the power supply, analog signals and digital communication. Analog is the default setting for the supply, signals including PV, PC and SVR can be used immediately once receiving the supply. The digital communication of PMBus or CAN bus is initially uncontrollable but readable. To activate the digital communication, please set PM\_CTRL/CAN\_CTRL of SYSTEM\_CONFIG(PM: BEh; CAN: 0x00C2) at "1" and then reboot the supply. Once the digital communication dominates the supply, the analog signals become invalid.

- NOTE: 1. At default setting of analog, the following commands are invalid but can be written while other commands are effective: OPERATION(PM:01h; CAN: 0x0000), VOUT\_TRIM/VOUT\_SET(PM: 22h; CAN: 0x0020) and IOUT\_OC\_FAULT\_LIMIT/OUT\_SET(PM: 46h; CAN: 0x0030).
2. All written parameters of commands: PM: 01h, 22h and 46h; CAN: 0x0000, 0x0020 and 0x0030 are saved into EEPROM and take effect after the digital is activated.

### 4.1 PMBus Addressing and CAN ID setting

- ⊙ Each PHP-3500 unit should have their unique and own device address to communicate over the bus.

\*PMBus 7-bit addressing definition:

MSB				LSB		
1	0	0	0	A2	A1	A0

\*CAN message ID definition :

Message ID	Description
0x000C00XX	PHP-3500 to Controller Message ID
0x000C01XX	Controller to PHP-3500 Message ID
0x000C01FF	Controller broadcasts to PHP-3500

XX means the CAN ID of PHP-3500

A0-A2 allow users to designate an address for PHP-3500 units; these three bits are defined through a 3-pole DIP switch on the terminal end of the unit. There are up to 8 different addresses available to be assigned. When DIP switch in the "ON" position means logic "0"; when it is in the "OFF" position, meaning logic "1", for example, position 3 in "OFF", the corresponding bit, A2, is set to logic "1". Please refer to Table 4-1 for the detailed setup advice.



Module No.	Device address/ID			Module No.	Device address/ID		
	A0	A1	A2		A0	A1	A2
	DIP switch position				DIP switch position		
	1	2	3		1	2	3
0	ON	ON	ON	4	ON	ON	OFF
1	OFF	ON	ON	5	OFF	ON	OFF
2	ON	OFF	ON	6	ON	OFF	OFF
3	OFF	OFF	ON	7	OFF	OFF	OFF

Table 4-1

#### 4.2 PMBus Command List

©The command list of the PHP-3500 is shown in Table 4-2. It is compliant with the standard protocol of PMBus Rev 1.1. For more detailed information, please refer to PMBus official website(<http://pmbus.org/specs.html>)

Command Code	Command Name	Transaction Type	# of data Bytes	Description
01h	OPERATION	R/W Byte	1	Remote ON/OFF control
02h	ON_OFF_CONFIG	Read Byte	1	ON/OFF function configuration
19h	CAPABILITY	Read Byte	1	Capabilities of a PMBus device
20h	VOUT_MODE	R Byte	1	Define data format for output voltage (format: Linear 16, N= -9)
21h	VOUT_COMMAND	R Word	2	Output voltage setting value (format: Linear 16, N= -9)
22h	VOUT_TRIM*	R/W Word	2	Output voltage trimmed value (format: Linear 16, N= -9)
46h	IOUT_OC_FAULT_LIMIT*	R/W Word	2	Output overcurrent setting value (format: Linear 11, N= -2)
47h	IOUT_OC_FAULT_RESPONSE	R Byte	1	Define protection and response when an output overcurrent fault occurred
79h	STATUS_WORD	R Word	2	Summary status reporting
7Ah	STATUS_VOUT	R Byte	1	Output voltage status reporting
7Bh	STATUS_IOUT	R Byte	1	Output current status reporting
7Ch	STATUS_INPUT	R Byte	1	AC input voltage status reporting
7Dh	STATUS_TEMPERATURE	R Byte	1	Temperature status reporting
7Eh	STATUS_CML	R Byte	1	Communication, logic, Memory status reporting
80h	STATUS_MFR_SPECIFIC	R Byte	1	Manufacture specific status reporting
88h	READ_VIN	R Word	2	AC input voltage reading value (format: Linear 11, N=-1)
8Bh	READ_VOUT	R Word	2	Output voltage reading value (format: Linear 16, N= -9)
8Ch	READ_IOUT	R Word	2	Output current reading value (format: Linear 11, N= -2)
8Dh	READ_TEMPERATURE_1	R Word	2	Temperature 1 reading value (format: Linear 11, N= -3)
98h	PMBUS_REVISION	R Byte	1	The compliant revision of the PMBus (default: 11h for Rev. 1.1)
99h	MFR_ID	Block Read	12	Manufacturer's name
9Ah	MFR_MODEL	Block Read	12	Manufacturer's model name
9Bh	MFR_REVISION	Block Read	24	Firmware revision
9Ch	MFR_LOCATION	Block R/W	3	Manufacturer's factory location

Command Code	Command Name	Transaction Type	# of data Bytes	Description
9Dh	MFR_DATE	Block R/W	6	Manufacture date. (format: YYMMDD)
9Eh	MFR_SERIAL	Block R/W	12	Product serial number
BEh	SYSTEM_CONFIG	R/W Word	2	System setting
BFh	SYSTEM_STATUS	Read Word	2	System status

Note: Setting commands with \* at the end support the EEP\_OFF function. For detailed information on how to enable them, please refer to SYSTEM\_CONFIG (BEh).

Table 4-2

◎ Definition of Command BEh SYSTEM\_CONFIG

	Bit7	Bit6	Bit5	Bit4	Bit3	Bit2	Bit1	Bit0
High byte	-	-	-	-	-	EEP_OFF	-	-
Low byte	-	-	-	-	-	OPERATION_INIT		PM_CTRL

Low byte

Bit 0 PM\_CTRL: PMBus Control Selecting

0= Output voltage and current controlled by SVR/PV/PC(default).

1= Output voltage, current and remote ON/OFF controlled by PMBus (VOUT\_TRIM、IOUT\_FAULT\_LIMIT、OPERATION).

Bit 1: 2 OPERATION\_INIT: Initial Operational Behavior

0b00= Power on with 0x00: OFF

0b01= Power on with 0x80: ON (factor default)

0b10= Power on with the last setting

0b11= Not used

High byte

Bit 2 EEP\_OFF: EEPROM storage function ON/OFF

0: Enable. Parameters to be saved into EEPROM (factor default)

1: Disable. Parameters NOT to be saved into EEPROM

Note: Unsupported settings display with "0"

◎ Definition of Command BFh SYSTEM\_STATUS

	Bit7	Bit6	Bit5	Bit4	Bit3	Bit2	Bit1	Bit0
High byte	-	-	-	-	-	-	-	-
Low byte	-	EEPROM	INITIAL_STATE	ADL_ON	-	PFC_OK	DC_OK	M/S

Low byte

Bit 0 M/S: Master/Slave Indication

0= The unit is a slave

1= The unit is the master

Bit 1: DC\_OK: The DC Output Status

0= DC output too low

1= DC output at a normal range

Bit 2 PFC\_OK : The PFC Status

0= The PFC NOT activate or abnormal

1= The PFC activate

Bit 4 ADL\_ON : Active Dummy Load Status

0= Active dummy load NOT activate

1= Active dummy load activate

Bit 5 INITIAL\_STATE: Initial State Indication

0= The unit NOT in an initial state

1= The unit in an initial state

Note: Unsupported settings display with "0"

Bit 6 EEPER: EEPROM Access Error

0= EEPROM accessing normally

1= EEPROM access error

Note:

EEPER: When EEPROM Access Error occurs, the supply stops working and the LED indicator turns red. The supply needs to re-power on to recover after the error condition is removed.

#### 4.2.1 PMBus Data Range and Tolerance

##### ◎Display parameters

	PMBus command	Model	Range	Tolerance
88h	READ_VIN	ALL	80 ~ 264V	±10V
8Bh	READ_VOUT	24V	0 ~ 28.8V	±0.24V
		48V	0 ~ 57.6V	±0.48V
8Ch	READ_IOUT (Note. 1)	24V	0 ~ 180A	±6A
		48V	0 ~ 90A	±3A
8Dh	READ_TEMPERATURE_1	ALL	-40 ~ 100°C	±5°C

Table 4-3

##### ◎Control parameter

	PMBus command	Model	Range	Tolerance	Default
01h	OPERATION	ALL	00h(OFF) / 80h(ON)	N/A	80h(ON)
21h	VOUT_COMMAND (Note. 2)	24V	24V	N/A	24V
		48V	48V	N/A	48V
22h	VOUT_TRIM (Note. 2)	24V	-12 ~ 4.8V	±0.24V	0V
		48V	-24 ~ 9.6V	±0.48V	0V
46h	IOUT_OC_FAULT_LIMIT	24V	29 ~ 159.5A	±6A	159.5A
		48V	14.75 ~ 80.25A	±3A	80.25A
BEh	SYSTEM_CONFIG	ALL	N/A	N/A	02h

Table 4-4

##### Note:

1.READ\_IOUT will display ZERO amp when output current is less than the values in the table below.

Model	Minimum readable current
24V	6A±1A
48V	3A±1A

Table 4-5

2.When using PMBus to adjust output voltage, VOUT\_COMMAND only can be used to display the rated voltage of the unit and cannot be written. It is VOUT\_TRIM that provides voltage trimming function. Take PHP-3500-24 as an examples, to get a 12V output, please set value of VOUT\_TRIM to -12V. Adjustable voltage range for each model is shown as below.

Model	Adjustable voltage range
24V	12 ~ 28.8V
48V	24 ~ 57.6V

Table 4-6

3.Due to the limited write cycles of the EEPROM, it is advisable to consider using the SYSTEM\_CONFIG (BEh) command to select an appropriate EEPROM writing logic, especially if communication settings are frequently altered.

#### 4.2.2 Notes on PMBus

1. Insert a at least 50msec delay between commands

2. Examples for Format Conversion :

(1) LINEAR16 format : VOUT\_COMMAND · VOUT\_TRIM · READ\_VOUT · CURVE\_CV · CURVE\_FV ·

Actual voltage = communication reading  $V \times 2^N$ . There are two definitions in the VOUT\_MODE command that refer to N requirements.

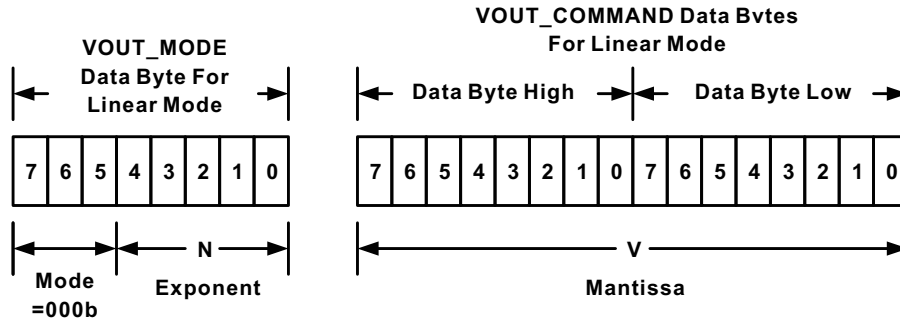

Linear Format Data Bytes

The Mode bits are set to 000b.

The Voltage, in volts, is calculated from the equation:

$$\text{Voltage} = V \cdot 2^N$$

Where:

Voltage is the parameter of interest in volts;

V is a 16 bit unsigned binary integer; and

N is a 5 bit two's complement binary integer.

EX:  $V_{o\_real}$  (actual output voltage) =  $V \times 2^N$ , V is from READ\_VOUT. N If VOUT\_MODE = 0x17, meaning N is -9. READ\_VOUT is 0x3000 12288, then  $V_{o\_real} = 12288 \times 2^{-9} = 24.0V$ .

(2) LINEAR11 format : IOUT\_OC\_FAULT\_LIMIT · READ\_VIN · READ\_IIN · READ\_IOUT ·

READ\_TEMPERATURE\_1 · READ\_FAN\_SPEED\_1 · READ\_FAN\_SPEED\_2 · CURVE\_CC · CURVE\_TC · CURVE\_CC\_TIMEOUT · CURVE\_CV\_TIMEOUT · CURVE\_FV\_TIMEOUT ·

Actual value X = communication read value Y x  $2^N$ . Among them, the definition of the description column for each aircraft type is referred to.

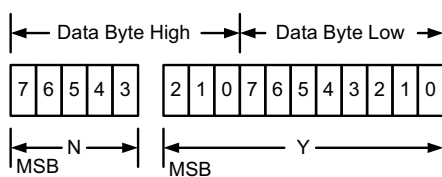

Linear Data Format Data Bytes Y, N and the "real world" value is:

The relation between

$$X = Y \cdot 2^N$$

Where, as described above:

X is the "real world" value;

Y is an 11 bit, two's complement integer; and

N is a 5 bit, two's complement integer.

Devices that use the Linear format must accept and be able to process any value of N.

EX:  $I_{o\_real}$  (actual output current) =  $Y \times 2^N$ , Y is from READ\_IOUT. N If READ\_IOUT is 0xF188h, meaning N is -2 and Y is 0x0188. Y is 0x0188  $\rightarrow$  392, then  $I_{o\_real} = 392 \times 2^{-2} = 98.0A$ .

### 4.2.3 Communication Example - Practical Operation of Power Supply Mode

The following steps will describe how to set the PHP-3500-48 to 56V.

1. Set the address of the supply to "0". Set the DIP switch located in the middle of the input and output terminals to ON/ON/ON.



2. Connect the SDA/SCL/GND to SDA(pin 21), SCL(pin 19) and GND-AUX(S)(pin 17) of CN55.

◎Set speed: 100KHz

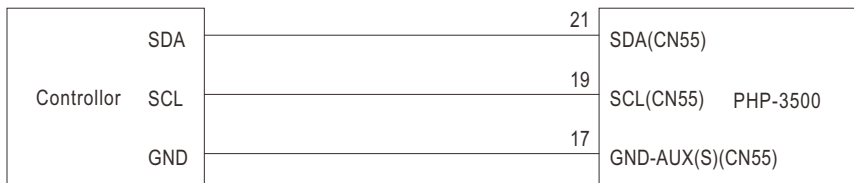

3. Communication function can be accessed immediately after PHP-3500 is connected to AC. First set it to communication mode.

Address(7 bit)	Operation	Command Code	Data
0x40	Write	0xBE	0x03, 0x00

Command code: 0xBE (SYSTEM\_CONFIG)

Data: 03(Lo) + 00(Hi). Please refer to definition of SYSTEM\_CONFIG for detailed information.

4. Set output voltage at 56V.

Address(7 bit)	Operation	Command Code	Data
0x40	Write	0x22	0x00, 0x02

Command code: 0x22 (VOUT\_TRIM)

Data: 1V → 0x0200 → 0x02, 0x00

NOTE: VOUT\_TRIM is LINEAR16 format

5. It is recommended to review all of the settings and parameters using the appropriate commands. In the event that they do not meet your requirements, you may rewrite them as needed.

NOTE: Read VOUT\_TRIM to check whether output voltage was set to a proper level.

Read VOUT\_TRIM

Address(7 bit)	Operation	Command Code
0x40	Read	0x22

The unit returns data below

Address(7 bit)	Data
0x40	0x00, 0x10

Data: 0x00(Lo) + 0x10(Hi) → 0x1000 →  $4096 \times 2^{-9} = 8V$ .  $48 + 8V = 56V$ , the result is correct.

6. Finally, check whether Remote ON-OFF (PIN3) and +12V-AUX (PIN1) pins of the CN47 connector are short-circuited if there is no output voltage.

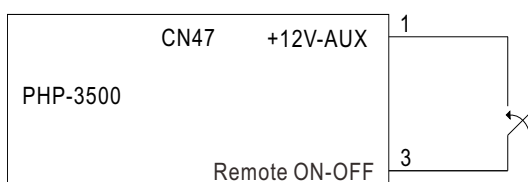

### 4.3 CANBus Communication Interface

⊙Physical layer specification

This protocol follows CAN ISO-11898 with Baud rate of 250Kbps.

⊙Data Frame

This protocol uses Extended CAN 29-bit identifier frame format or CAN 2.0B.

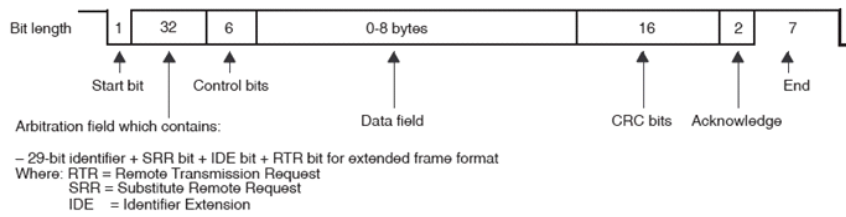

⊙Communication Timing

Min. request period (Controller to PHP-3500): 50mSec °

Max. response time (PHP-3500 to Controller): 12.5mSec °

Min. packet margin time (Controller to PSU/CHG): 12.5mSec °

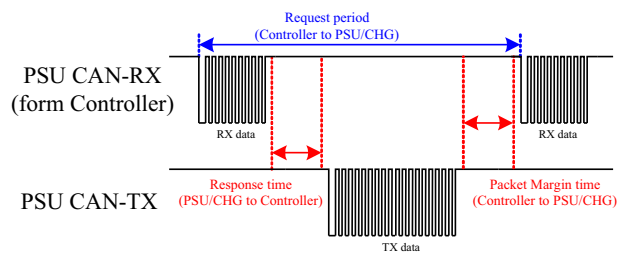

⊙Data Field Format

Controller to PHP-3500

Write:

Data filed bytes



Read:

Data filed bytes



PHP-3500 to Controller

Response:

Data filed bytes



NOTE: PHP-3500 will not send data back when writing parameters, such as VOUT\_SET

### 4.3.1 CANBus Command list

Command Code	Command Name	Transaction Type	# of data Bytes	Description
0x0000	OPERATION	R/W	1	ON/OFF control ON: 01h OFF: 00h
0x0020	VOUT_SET*	R/W	2	Output voltage set (format: value, F=0.01)
0x0030	IOUT_SET*	R/W	2	Output current set (format: value, F=0.01)
0x0040	FAULT_STATUS	R	2	Abnormal status
0x0050	READ_VIN	R	2	Input voltage read value (format: value, F=0.1)
0x0060	READ_VOUT	R	2	Output voltage read value (format: value, F=0.01)
0x0061	READ_IOUT	R	2	Output current read value (format: value, F=0.01)
0x0062	READ_TEMPERATURE_1	R	2	Internal ambient temperature (format: value, F=0.1)
0x0080	MFR_ID_B0B5	R	6	Manufacture's name
0x0081	MFR_ID_B6B11	R	6	Manufacture's name
0x0082	MFR_MODEL_B0B5	R	6	Manufacture model name
0x0083	MFR_MODEL_B6B11	R	6	Manufacture model name
0x0084	MFR_REVISION_B0B5	R	6	Firmware version
0x0085	MFR_LOCATION_B0B2	R	3	Manufacture place
0x0086	MFR_DATE_B0B5	R	6	Manufacture date
0x0087	MFR_SERIAL_B0B5	R	6	Manufacture serial number
0x0088	MFR_SERIAL_B6B11	R	6	Manufacture serial number
0x00C0	SCALING_FACTOR	R	6	Scaling ratio
0x00C1	SYSTEM_STATUS	R	2	System status
0x00C2	SYSTEM_CONFIG	R/W	2	System configuration

Note: Setting commands with \* at the end support the EEP\_OFF function. For detailed information on how to enable them, please refer to SYSTEM\_CONFIG (0x00C2).

Table 4-7

#### Data conversion :

The conversion of setting and reading values is defined as following:

Actual value = Communication reading value × Factor (F value). Among them, Factor needs to refer to the definition of SCALING\_FACTOR in each model list.

EX: Vo\_real (actual DC voltage) = READ\_VOUT x Factor.

If the Factory of READ\_VOUT of a certain mode is 0.01, the communication reading value is 0x0960 (hexadecimal)→2400(decimal), then VDC\_real = 2400 x 0.01 = 24.0V.



### 4.3.2 Definition and contents of CANBus Command list

©Definition of Command FAULT\_STATUS(0x0040) :

	Bit7	Bit6	Bit5	Bit4	Bit3	Bit2	Bit1	Bit0
High byte	-	-	-	-	-	-	-	-
Low byte	HI_TEMP	OP_OFF	AC_FAIL	SHORT	OLP	OVP	OTP	-

Low byte

Bit 1 OTP : Over temperature protection  
0 = Internal temperature normal  
1 = Internal temperature abnormal

Bit 2 OVP : DC over voltage protection  
0 = DC voltage normal  
1 = DC over voltage protected

Bit 3 OLP : DC over current protection  
0 = DC current normal  
1 = DC over current protected

Bit 4 SHORT : Short circuit protection  
0 = Shorted circuit do not exist  
1 = Shorted circuit protected

Bit 5 AC\_FAIL : AC abnormal flag  
0 = AC input range normal  
1 = AC input range abnormal

Bit 6 OP\_OFF : DC status  
0 = DC output turned on  
1 = DC output turned off

Bit 7 HI\_TEMP : Internal high temperature protection  
0 = Internal temperature normal  
1 = Internal temperature abnormal

Note: Unsupported settings displays with "0"

©MFR\_ID\_B0B5 (0x0080) is the first 6 codes of the manufacturer's name (ASCII); MFR\_ID\_B6B11 (0x0081) is the last 6 codes of the manufacturer's name (ASCII)

EX: Manufacturer's name is MEANWELL MFR\_ID\_B0B5 is MEANWE ; MFR\_ID\_B6B11 is LL

MFR_ID_B0B5					
Byte 0	Byte 1	Byte 2	Byte 3	Byte 4	Byte 5
0x4D	0x45	0x41	0x4E	0x57	0x45

MFR_ID_B6B11					
Byte 0	Byte 1	Byte 2	Byte 3	Byte 4	Byte 5
0x4C	0x4C	0x20	0x20	0x20	0x20

©MFR\_MODEL\_B0B5 (0x0082) is the first 6 codes of the manufacturer's model name (ASCII);  
MFR\_MODEL\_B6B11 (0x0083) is the last 6 codes of the manufacturer's model name (ASCII)  
EX: Model names is PHP-3500-48 → MFR\_MODEL\_B0B5 is PHP-35 ; MFR\_MODEL\_B6B11 is 00-48

MFR_MODEL_B0B5					
Byte 0	Byte 1	Byte 2	Byte 3	Byte 4	Byte 5
0x50	0x48	0x50	0x2D	0x33	0x35

MFR_ID_B6B11					
Byte 6	Byte 7	Byte 8	Byte 9	Byte 10	Byte 11
0x30	0x30	0x2D	0x34	0x38	0x20

©MFR\_REVISION\_B0B5 (0x0084) is the firmware revision (hexadecimal).  
A range of 0x00 (R00.0)~0xFE (R25.4) represents the firmware version of an MCU; 0xFF represents no MCU existed.

EX: The supply has two MCUs, the firmware version of the MCU number 1 is version R25.4 (0xFE), the MCU number 2 is version R10.5 (0x69)

Byte 0	Byte 1	Byte 2	Byte 3	Byte 4	Byte 5
0xFE	0x69	0xFF	0xFF	0xFF	0xFF

©MFR\_DATE\_B0B5 (0x0086) is manufacture date (ASCII)

EX: MFR\_DATE\_B0B5 is 180101, meaning 2018/01/01

Byte 0	Byte 1	Byte 2	Byte 3	Byte 4	Byte 5
0x31	0x38	0x30	0x31	0x30	0x31

©MFR\_SERIAL\_B0B5 (0x0087) and MFR\_SERIAL\_B6B11 (0x0088) are defined as manufacture date and manufacture serial number (ASCII)

EX: The first unit manufactured on 2018/01/01→MFR\_SERIAL\_B0B5: 180101 ; MFR\_SERIAL\_B6B11: 000001

Byte 0	Byte 1	Byte 2	Byte 3	Byte 4	Byte 5
0x31	0x38	0x30	0x31	0x30	0x31

Byte 6	Byte 7	Byte 8	Byte 9	Byte 10	Byte 11
0x30	0x30	0x30	0x30	0x30	0x31

©SCALING\_FACTOR(0x00C0) :

Bit7~Bit0								
byte4~5	Reserved							
	Bit7	Bit6	Bit5	Bit4	Bit3	Bit2	Bit1	Bit0
byte3	-				-			
	Bit7	Bit6	Bit5	Bit4	Bit3	Bit2	Bit1	Bit0
byte2	-				TEMPERATURE_1 Factor			
	Bit7	Bit6	Bit5	Bit4	Bit3	Bit2	Bit1	Bit0
byte1	-				VIN Factor			
	Bit7	Bit6	Bit5	Bit4	Bit3	Bit2	Bit1	Bit0
byte0	IOUT Factor				VOUT Factor			

byte0:

Bit 0:3 VOUT Factor : The factor of output voltage

0x0=Output voltage relevant commands not supported

0x4=0.001

0x5=0.01

0x6=0.1

0x7=1.0

0x8=10

0x9=100

Bit 4:7 IOUT Factor : The Factor of DC current

0x0=Output current relevant commands not supported

0x4=0.001

0x5=0.01

0x6=0.1

0x7=1.0

0x8=10

0x9=100

byte1:

Bit 0:3 VIN Factor : The Factor of AC input voltage

0x0=AC input relevant commands not supported

0x4=0.001

0x5=0.01

0x6=0.1

0x7=1.0

0x8=10

0x9=100

byte2:

Bit 0:3 TEMPERATURE\_1 Factor : The Factor of internal ambient temperature

0x0=internal ambient temperature relevant commands not supported

0x4=0.001

0x5=0.01

0x6=0.1

0x7=1.0

0x8=10

0x9=100

©SYSTEM\_STATUS(0x00C1) :

	Bit7	Bit6	Bit5	Bit4	Bit3	Bit2	Bit1	Bit0
High byte	-	-	-	-	-	-	-	-
Low byte	-	EEPER	INITIAL- LSTATE	ADL_ON	-	PFC_OK	DC_OK	M/S

Low byte :

Bit 0: M/S : Parallel mode status

0 = Current device is Slave

1 = Current device is Master

Bit 1 DC\_OK : Secondary DD output voltage status

0 = Secondary DD output voltage status TOO LOW

1 = Secondary DD output voltage status NORMAL

Bit 2: PFC\_OK : Primary PFC status

0 = Primary PFC OFF or abnormal

1 = Primary PFC ON normally

Bit 4 ADL\_ON : Active dummy load control status

0 = Active dummy load off/function not supported

1 = Active dummy load on

Bit 5 INITIAL\_STATE : Device initialized status

0 = NOT in initialization status

1 = In initialization status

Bit 6 EEPER : EEPROM data access error

0 = EEPROM data access normal

1 = EEPROM data access error

Note: Unsupported settings displays with "0"

©SYSTEM\_CONFIG(0x00C2) :

	Bit7	Bit6	Bit5	Bit4	Bit3	Bit2	Bit1	Bit0
High byte	-	-	-	-	-	EEP_OFF	-	-
Low byte	-	-	-	-	-	OPERATION_INIT		CAN_CTRL

Low byte :

Bit 0 CAN\_CTRL : CANBus communication control status

0 = The output voltage/current defined by control over SVR/PV/PC (factory default)

1 = The output voltage, current, ON/OFF control defined by control over

CANBus (VOUT\_SET, IOOUT\_SET, OPERATION)

Bit 1:2 OPERATION\_INIT : Pre-set value of power on operation command

0b00 = Power OFF, pre-set 0x00(OFF)

0b01 = Power ON, pre-set 0x01(ON) (factory default)

0b10 = Pre-set is previous set value

0b11 = not used, reserved

High Byte :

EEPROM storage function ON/OFF

0: Enable. Parameters to be saved into EEPROM (factory default)

1: Disable. Parameters NOT to be saved into EEPROM

Note: Unsupported settings displays with "0"

### 4.3.3 CANBus Value Range and Tolerance

#### ◎Display parameters

	CANBus command	Model	Display value range	Tolerance
0x0050	READ_VIN	ALL	80 ~ 264V	±10V
0x0060	READ_VOUT	24V	0 ~ 28.8V	±0.24V
		48V	0 ~ 57.6V	±0.48V
0x0061	READ_IOUT (Note. 1)	24V	0 ~ 180A	±6A
		48V	0 ~ 90A	±3A
0x0062	READ_TEMPERATURE_1	ALL	-40 ~ 100°C	±5°C

#### ◎Control parameters

	CANBus command	Model	Adjustable range	Tolerance	Default
0x0000	OPERATION	ALL	0x00(OFF)/0x01(ON)	N/A	0x01
0x0020	VOUT_SET	24V	12 ~ 28.8V	±0.24V	24V
		48V	24 ~ 57.6V	±0.48V	48V
0x0030	IOUT_SET	24V	29 ~ 159.5A	±6A	159.5A
		48V	14.75 ~ 80.25A	±3A	80.25A
0x00C2	SYSTEM_CONFIG 0x0002	ALL	N/A	N/A	0x0002

#### Note:

1. READ\_IOUT will display ZERO amp when output current is less than the values in the table below.

Model	Minimum readable current
24V	6A±1A
48V	3A±1A

2. Due to the limited write cycles of the EEPROM, it is advisable to consider using the SYSTEM\_CONFIG (0x00C2) command to select an appropriate EEPROM writing logic, especially if communication settings are frequently altered.

### 4.3.4 CANBus Communication example

#### 4.3.4.1 Sending command

The master adjusts output voltage of the unit with address "01" to 30V.

CAN ID	DLC (data length)	Command code	Parameters
0x000C0101	0x4	0x2000	0xB80B

Command code: 0x0020 (VOUT\_SET) → 0x20(Lo) + 0x00(Hi)

Parameters: 30V → 3000 → 0x0BB8 → 0xB8(Lo) + 0x0B(Hi)

NOTE: Conversion factor for VOUT\_SET is 0.01, so  $\frac{30V}{F=0.01} = 3000$

#### 4.3.4.2 Reading data or status

The master reads operation setting from the unit with address "00".

CAN ID	DLC (data length)	Command code
0x000C0100	0x2	0x0000

The unit with address "00" returns data below

CAN ID	DLC (data length)	Command code	Parameters
0x000C0000	0x3	0x0000	0x01

Parameters: 0x01 ON, meaning that the unit with address "00" is operating.

#### 4.3.4.3 Communication Example - Practical Operation of Power Supply Mode

The following steps will describe how to set the PHP-3500-48 to 56V.

1. Set the address of the supply to "0". Set the DIP switch located in the middle of the input and output terminals to ON/ON/ON.



2. Connect the CANH/CANL to CN55 CANH(pin 21), CANL(pin 19). Make the signals at the same level to increase communication reliability, that is: connect to the GND-AUX(S)(17) of CN55.

Ⓞ Set baud rate: 250kbps, type: extended

Ⓞ Adding a 120Ω terminal resistor to both the controller and power supply ends can increase communication stability

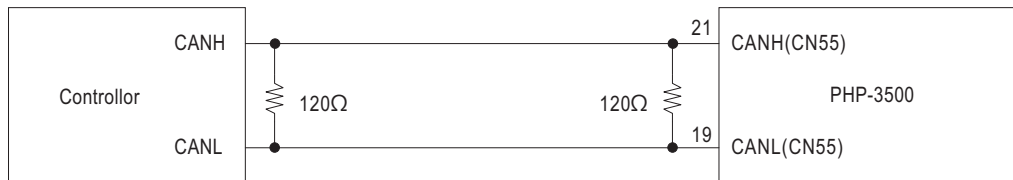

3. Communication function can be accessed immediately after PHP-3500 is connected to AC. First set it to communication mode.

CANID	DLC(data length)	Command Code	Parameters
0x000C0100	0x04	0xC200	0x0300

Command code: 0x00C2 (SYSTEM\_CONFIG)

Data: 03(Lo) + 00(Hi). Please refer to definition of SYSTEM\_CONFIG for detailed information.

4. Set output voltage at 56V.

CANID	DLC(data length)	Command Code	Parameters
0x000C0100	0x04	0x2000	0xE015

Command code: 0x0020(VOUT\_SET)

Data: 56V → 5600 → 0x15E0 → 0xE0(Lo) + 0x15(Hi)

NOTE: Conversion factor for CURVE\_CV is 0.01, so  $\frac{56V}{F=0.01} = 5600$

5. It is recommended to review all of the settings and parameters using the appropriate commands. In the event that they do not meet your requirements, you may rewrite them as needed.

EX: Read READ\_VOUT to check whether output voltage was set to a proper level.

Read READ\_VOUT

CANID	DLC(data length)	Command Code
0x000C0100	0x02	0x6000

The unit returns data below

CANID	DLC(data length)	Command Code	Parameters
0x000C0000	0x04	0x6000	0xE015

Data: 0xE0(Lo) + 0x15(Hi) → 0x15E0 → 5600 x 0.01 = 56V °

6. Finally, check whether Remote ON-OFF (PIN3) and +12-AUX (PIN1) pins of the CN47 connector are short-circuited if there is no output voltage.

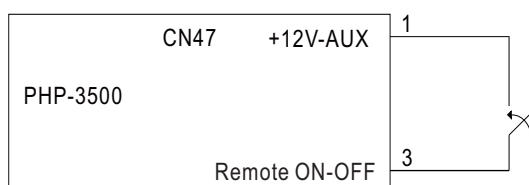

## 5. Note on Operation

### 5.1 Installation Method

© Suggested wire selection for input/out wirings.

Input/output	Module	Current	Minimum Cross-section of copper wire	Maximum Current
115VAC	1 unit	20Arms	12AWG UL1015	22A
230VAC	1 unit	17Arms	12AWG UL1015	22A
+24VDC	1 unit	145Adc	50mm <sup>2</sup>	190A
	2 unit	290Adc	100mm <sup>2</sup>	298A
	3 unit	435Adc	200mm <sup>2</sup>	469A
	4 unit	580Adc	325mm <sup>2</sup>	665A
+48VDC	1 unit	73Adc	22mm <sup>2</sup>	115A
	2 unit	146Adc	50mm <sup>2</sup>	190A
	3 unit	219Adc	80mm <sup>2</sup>	257A
	4 unit	292Adc	100mm <sup>2</sup>	298A
Other commonly used wires			16AWG UL1015	8A
			12AWG UL1015	22A
			10AWG UL1015	35A
			30mm <sup>2</sup>	139A
			50mm <sup>2</sup>	190A
			60mm <sup>2</sup>	217A
			80mm <sup>2</sup>	257A
			100mm <sup>2</sup>	298A
			125mm <sup>2</sup>	344A
			150mm <sup>2</sup>	395A
200mm <sup>2</sup>	469A			
250mm <sup>2</sup>	556A			
325mm <sup>2</sup>	665A			

Table 5-1 Suggested wire selection for input/output wirings

### 5.2 Derating

© When PHP-3500 is operating at a lower AC input voltage, the unit will derate its output current automatically to protect itself, shown as Figure 5-2.

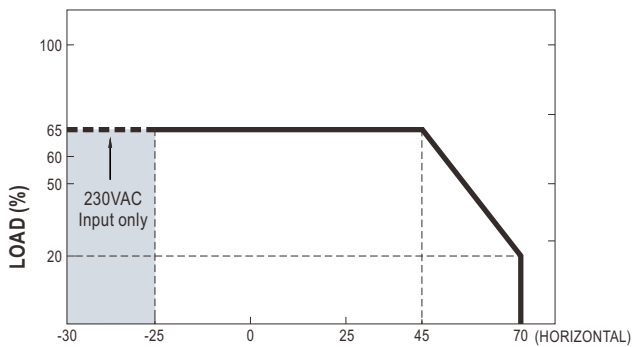

AMBIENT TEMPERATURE WITH ADDITIONAL ALUMINUM PLATE(°C)  
(450x450x3mm)

Note. Tcase max. ≤ 70°C and ambient temp must be within above de-rating curve.

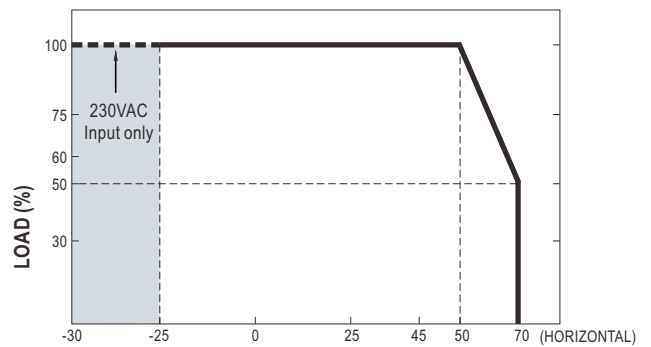

AMBIENT TEMPERATURE WITH 128 CFM FAN\*2 OR WATER COOLING SYSTEM (°C)

Note. Tcase max. ≤ 45°C and ambient temp must be within above de-rating curve.

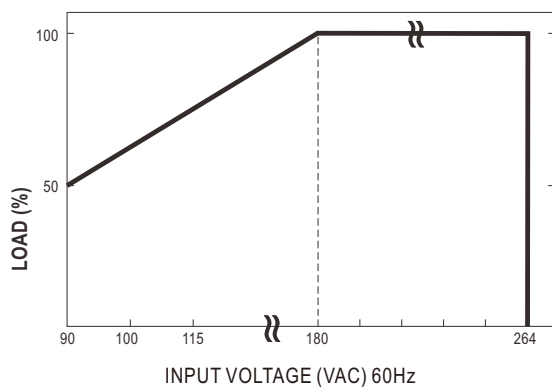

### 5.3 Water Cooling System

#### 5.3.1 Quality requirement for water cold plate surfaces

- ⊙ There should be no any shrinkage cavity, corrosion or cracks on the surfaces.

#### 5.3.2 Operational requirement for water cooling loop

- ⊙ Using good quality water is recommended, resistance < 2.5KΩ and having a pH of 6-9; Inlet temperature of 25°C, flow rate of 1 liter per minute.
- ⊙ Please make sure there is no fluid leaks, blocks or condensation under operation.

#### 5.3.3 Note on water cold plate design

- ⊙ Material (purity, thickness, machining precision, etc) and manufacturing craft (whether there are cracks, fractures, etc caused by extrusion) have an profound impact on thermal conductivity of a cold plate.
- ⊙ Flatness between mating parts plays a critical role in thermal contact conductance.
- ⊙ Please make sure cooling capacity of the chiller is greater than 175W so as to dissipate heat from the power supply efficiently.

#### 5.3.4 Condensation prevention and control

It is important to minimize or prevent condensation because condensate could drip onto electronics or collect in the bottom of the system and cause corrosion. To avoid condensation, please follow below:

- ⊙ Temperature difference between the water and ambient temperature should be lower than 5°C in hot and humid places.
- ⊙ Turn off the water cooling system during a power outage.

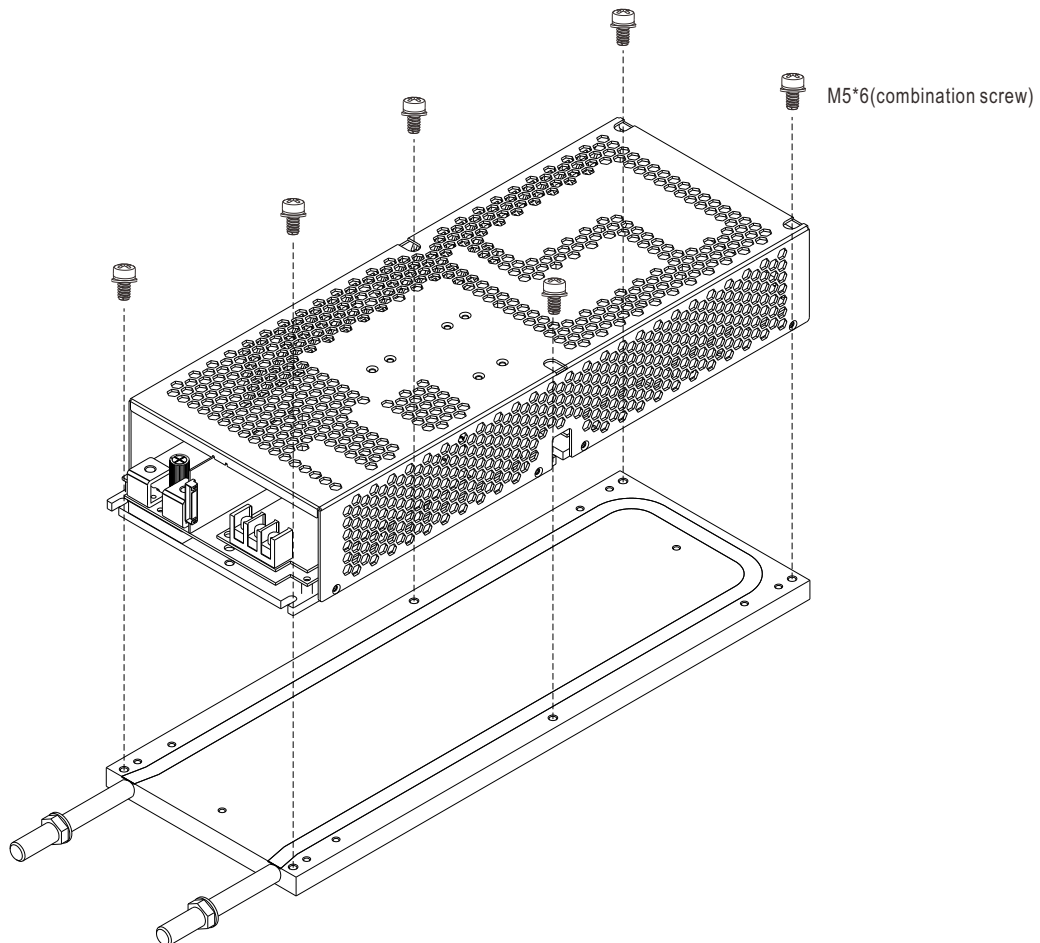

Optional MEAN WELL cold plate is ready for order, Ordering No.: PGG1WHS-656

### 5.4 Warranty

- ⊙ A five year global warranty is provided under normal operation. Please do not change any component or modify the unit by yourself or MEANWELL may reserve the right not to provide the complete warranty service.



明緯企業股份有限公司

MEAN WELL ENTERPRISES CO., LTD.

248 新北市五股區五權三路28號

No.28, Wuquan 3rd Rd., Wugu Dist., New Taipei City 248, Taiwan

Tel: 886-2-2299-6100 Fax: 886-2-2299-6200

<http://www.meanwell.com> E-mail: [info@meanwell.com](mailto:info@meanwell.com)

*Your Reliable Power Partner*