

UHP-1500-HV Communication Note

- A.PMBus communication interface..... 1**
- 1.Set the PMBus address 1
- 2.PMBus control setting mode 1
- 3.Command 01h Operational Behavior Setting 1
- 4.PMBus Command List..... 2
- 5.PMBus Data Range and Tolerance 3
- 6. Practical Operation..... 6
- B.CANBus Communication Interface..... 7**
- 1. CANBus Communication Interface..... 7
- 2. UHP-1500-HV Message ID definition description..... 7
- 3. CANBus command list..... 8
- 4. UHP-1500-HV CANBus value range and error 9
- 5. Definition and contents of CANBus Command list..... 9
- 6. Communication example 11
- C.Factory Resetting 12**



UHP-1500-HV communication instruction

A.PMBus communication interface

◎ UHP-1500 is compliant with PMBus Rev.1.1, the maximum communication speed is 100KHz and the maximum number of assignable addresses is up to 8 units on a bus.

◎ PMBus communication interface is able to provide the current operating status and information as follows:

1. Output voltage, current and internal temperature.
2. Alarm and status
3. Manufacturer's and model data.

1.Set the PMBus address

◎ When communicating with PMBus, each UHP-1500 must be configured with a unique and non-duplicate device address.

The 7-bits addressing mode of the UHP-1500 is defined below.

MSB				LSB		
1	0	0	0	A2	A1	A0

It can be set by the 3-pole DIP switch. When the switch is placed in the upper ON position, it is a logical "0", and when placed in the lower OFF position, it is a logical "1". DIP switch can specify eight different addresses.

Table 1-1 shows the switch positions and corresponding addresses.



Module No.	Device address		
	A0	A1	A2
	DIP switch position		
	1	2	3
0	ON	ON	ON
1	OFF	ON	ON
2	ON	OFF	ON
3	OFF	OFF	ON
4	ON	ON	OFF
5	OFF	ON	OFF
6	ON	OFF	OFF
7	OFF	OFF	OFF

Table 1-1

2.PMBus control setting mode

◎ The default source of power mode control is PV/PC or SVR control, while PMBus control needs to be started using PM_CTRL in Command BEh. When the PMBus control is enabled, the machine can be set by OPERATION(01h), VOUT_TRIM(22h), IOUT_OC_FAULT_LIMIT(46h) and other commands. The OPERATION, VOUT_TRIM, and IOUT_OC_FAULT_LIMIT commands are configurable but not valid. For details about the command control mode and value, see 4. Command List.

NOTE: The OPERATION, VOUT_TRIM, IOUT_OC_FAULT_LIMIT Settings will be stored in EEPROM and will be reloaded at the next startup.

3.Command 01h Operational Behavior Setting

◎ Initial behavior of the power supply can be changed by setting OPERATION_INIT of SYSTEM_CONFIG(BEh), for example: power on without output.

For detailed information, please refer to 4. Command List.

4.PMBus Command List

- ◎ The command list of the UPH-1500 is shown in Table 4-1. It is compliant with the standard protocol of PMBus Rev 1.1. For more detailed information, please refer to PMBus official website (<http://pmbus.org/specs.html>) .

Command Code	Command Name	Transaction Type	# of data Bytes	Description
01h	OPERATION	R/W Byte	1	Remote ON/OFF control
02h	ON_OFF_CONFIG	Read Byte	1	ON/OFF function configuration
19h	CAPABILITY	Read Byte	1	Capabilities of a PMBus device
20h	VOUT_MODE	R Byte	1	Define data format for output voltage (format: Linear 16, N= -7)
21h	VOUT_COMMAND	R Word	2	Output voltage setting value (format: Linear 16, N= -9)
22h	VOUT_TRIM	R/W Word	2	Output voltage trimmed value (format: Linear 16, N= -9)
46h	IOUT_OC_FAULT_LIMIT	R/W Word	2	Output overcurrent setting value (380V:format linear 11,N=-7 230V/115V:format linear 11,N=-6)
47h	IOUT_OC_FAULT_RESPONSE	R Byte	1	Define protection and response when an output overcurrent fault occurred
79h	STATUS_WORD	R Word	2	Summary status reporting
7Ah	STATUS_VOUT	R Byte	1	Output voltage status reporting
7Bh	STATUS_IOUT	R Byte	1	Output current status reporting
7Ch	STATUS_INPUT	R Byte	1	AC input voltage status reporting
7Dh	STATUS_TEMPERATURE	R Byte	1	Temperature status reporting
7Eh	STATUS_CML	R Byte	1	Communication, logic, Memory status reporting
80h	STATUS_MFR_SPECIFIC	R Byte	1	Manufacture specific status reporting
88h	READ_VIN	R Word	2	AC input voltage reading value (format: Linear 11, N=-1)
8Bh	READ_VOUT	R Word	2	Output voltage reading value (format: Linear 16, N= -7)
8Ch	READ_IOUT	R Word	2	Output current reading value (380V:format linear 11,N=-7 230V/115V:format linear 11,N=-6)
8Dh	READ_TEMPERATURE_1	R Word	2	Temperature 1 reading value (format: Linear 11, N= -3)
98h	PMBUS_REVISION	R Byte	1	The compliant revision of the PMBus (default: 11h for Rev. 1.1)
99h	MFR_ID	Block Read	12	Manufacturer's name
9Ah	MFR_MODEL	Block Read	12	Manufacturer's model name
9Bh	MFR_REVISION	Block Read	24	Firmware revision
9Ch	MFR_LOCATION	Block R/W	3	Manufacturer's factory location
9Dh	MFR_DATE	Block R/W	6	Manufacture date. (format: YYMMDD)
9Eh	MFR_SERIAL	Block R/W	12	Product serial number
BEh	SYSTEM_CONFIG	R/W Word	2	System setting
BFh	SYSTEM_STATUS	Read Word	2	System status

Table 4-1

◎ Definition of Command BEh SYSTEM_CONFIG:

	Bit7	Bit6	Bit5	Bit4	Bit3	Bit2	Bit1	Bit0
High byte	-	-	-	-	-	-	-	-
Low byte	-	-	-	-	-	OPERATION_INIT		PM_CTRL

Low byte

Bit 0 PM_CTRL: PMBus Control Selecting

0=Output voltage and current controlled by SVR/PV/PC(default))

1=Output voltage, current and remote ON/OFF controlled by PMBus (VOUT_TRIM, IOUT_FAULT_LIMIT, OPERATION))

Bit 1: 2 OPERATION_INIT: Initial Operational Behavior

0b00=Power on with 0x00: OFF

0b01=Power on with 0x80: ON (default)

0b10=Power on with the last setting

0b11=Not used

Note: Unsupported settings display with "0"

◎ Definition of Command BFh SYSTEM_STATUS:

	Bit7	Bit6	Bit5	Bit4	Bit3	Bit2	Bit1	Bit0
High byte	-	-	-	-	-	-	-	-
Low byte	-	EEPER	INITIAL_STATE	ADL_ON	-	-	DC_OK	-

Low byte

Bit 1: DC_OK: The DC Output Status

0=DC output too low

1=DC output at a normal range

Bit 4 ADL_ON: Active dummy load Status

0=Active dummy load NOT activate

1=Active dummy load activate

Bit 5 INITIAL_STATE: Initial State Indication

0=The unit NOT in an initial state

1=The unit in an initial state

Note: Unsupported settings display with "0"

Bit 6 EEPER: EEPROM Access Error

0=EEPROM accessing normally

1=EEPROM access error

Note:

EEPROM: When EEPROM Access Error occurs, the supply stops working and the LED indicator turns off. The supply needs to repower on to recover after the error condition is removed

5. PMBus Data Range and Tolerance

◎ Display parameters

	PMBus command	Model	Range	Tolerance
88h	READ_VIN	ALL	80 ~ 264V	±10V
8Bh	READ_VOUT	115V	0 ~ 138V	±1.15V
		230V	0 ~ 260V	±2.3V
		380V	0 ~ 400V	±3.8V
8Ch	READ_IOUT (Note. 1)	115V	0 ~ 14.36A	±0.7A
		230V	0 ~ 7.7A	±0.4A
		380V	0 ~ 4.95A	±0.25A
8Dh	READ_TEMPERATURE_1	ALL	-40 ~ 110°C	±5°C

Table 5-1

© Control parameters

	PMBus command	Model	Range	Tolerance	Default
01h	OPERATION	ALL	00h(OFF) / 80h(ON)	N/A	80h(ON)
21h	VOUT_COMMAND (Note. 2)	115V	115V	N/A	115V
		230V	230V	N/A	230V
		380V	380V	N/A	380V
22h	VOUT_TRIM (Note. 2)	115V	-48 ~ 45V	±1.15V	0V
		230V	-122 ~ 30V	±2.3V	0V
		380V	-213 ~ 20V	±3.8V	0V
46h	IOUT_OC_FAULT_LIMIT	115V	2.61 ~ 13.05A	±0.7A	13.05A
		230V	1.4 ~ 7A	±0.4A	6.52A
		380V	0.9 ~ 4.5A	±0.25A	3.95A
BEh	SYSTEM_CONFIG	ALL	N/A	N/A	02h

Table 5-2

Note:

1. READ_IOUT will display ZERO amp when output current is less than the values in the table below

Model	Minimum readable current
115V	0.52A±0.1A
230V	0.28A±0.1A
380V	0.18A±0.1A

Table 5-3

2. When using PMBus to adjust output voltage, VOUT_COMMAND only can be used to display the rated voltage of the unit and cannot be written. It is VOUT_TRIM that provides voltage trimming function. Take UHP-1500-115 as an examples, to get a 67V output, please set value of VOUT_TRIM to -48V. Adjustable voltage range for each model is shown as below

Model	Adjustable voltage range
115V	57.5 ~ 138V
230V	108 ~ 260V
380V	167 ~ 400V

Table 5-4

3. Insert a at least 35msec delay between commands.

4. Set and read numeric conversion instructions

(1) LINEAR16 format: VOUT_COMMAND、VOUT_TRIM、READ_VOUT. Actual voltage = Communication reading $V \times 2^N$. The value of N is defined in the VOUT_MODE command.

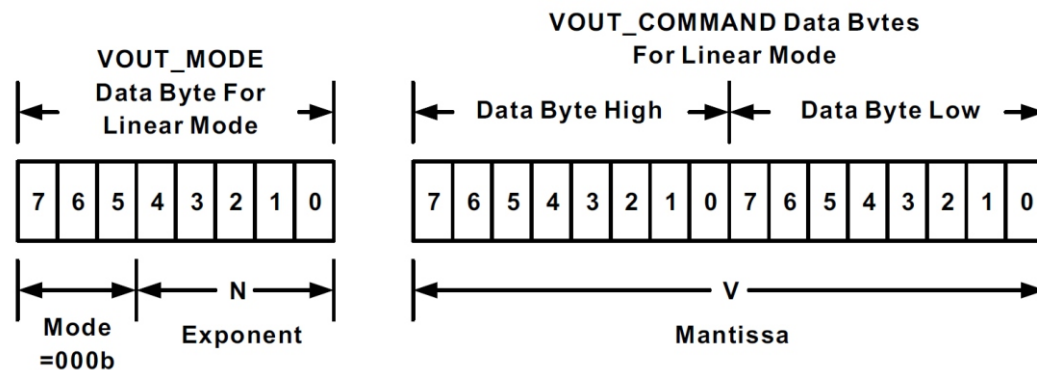

Linear Format Data Bytes

The Mode bits are set to 000b.

The Voltage, in volts, is calculated from the equation:

$$\text{Voltage} = V \times 2^N$$

Where:

Voltage is the parameter of interest in volts;

V is a 16 bit unsigned binary integer; and

N is a 5 bit two's complement binary integer.

EX: Vo_real(actual output voltage) = $V \times 2^N$. IF VOUT_MODE=0x17, meaning N is-7.

READ_VOUT is 0xBE00 → 48640, then Vo_real = $48640 \times 2^{-7} = 380V$.

(2) LINEAR11 format: IOUT_OC_FAULT_LIMIT, READ_VIN, READ_IIN, READ_IOUT, READ_TEMPERATURE_1, READ_FAN_SPEED_1, READ_FAN_SPEED_2.

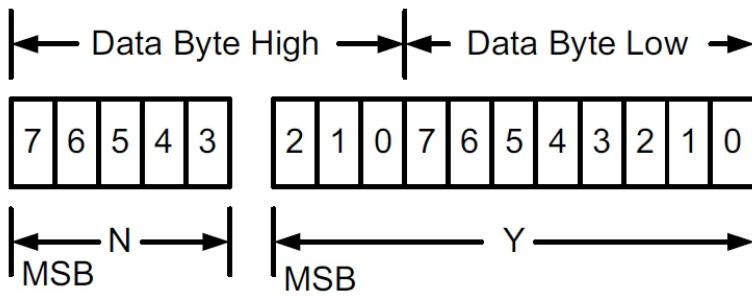

Linear Data Format Data Bytes Y, N and the "real world" value is:

The relation between

$$X = Y \times 2^N$$

Where, as described above:

X is the "real world" value;

Y is an 11 bit, two's complement integer; and

N is a 5 bit, two's complement integer.

Devices that use the Linear format must accept and be able to process any value of N

EX: $lo_real(\text{actual output current}) = Y \times 2^N$. IF READ_IOUT is 0xCA40h, meaning N is -7 and Y is 0x0240 \rightarrow 576, then $lo_real = 576 \times 2^{-7} = 4.5A$

6. Practical Operation

The following steps will describe how to set the UHP-1500-380 to 330V.

1. Set the address of the charger to "0", Refer to Table 1-1
2. Connect the SDA, SCL and GND pins of the master to the corresponding SDA (PIN7) and SCL (PIN8) of CN77 and GND-AUX (PIN3&PIN4) of CN77 on the supply.

© Set speed: 100KHz



3. Communication function can be accessed immediately after UHP-1500-380 is connected to AC. Set output voltage at 330V.

Address(7 bit)	Operation	Command Code	Data
0x40	Write	0x22	0x00, 0x 9C

Command code: 0x22(VOUT_TRIM)
Data: 330V → 0x00(Lo) + 0x9C(Hi)

4. It is recommended to review all of the settings and parameters using the appropriate commands. In the event that they do not meet your requirements, you may rewrite them as needed. EX: Read VOUT_TRIM to check whether output voltage was set to a proper level.

Address(7 bit)	Operation	Command Code	Data
0x40	Write	0x22	0x00, 0x 9C

READ VOUT_TRIM

Address(7 bit)	Operation	Command Code
0X40	Read	0X22

The unit returns data below

Address(7 bit)	Data
0X40	0x00,0x9C

Data: 0x00(Lo) + 0x9C(Hi) → 0x9C00 → $-25600 \times 2^{-9} = -50V$.
380V-50V = 330V, the result is correct

5. Finally, if the power supply has no output, please confirm that the Remote ON-OFF pin of the CN82 is shorted with PIN3&PIN4 (GND). Also please make sure command sending/reading is in an interval of below 4 sec in order not to trigger

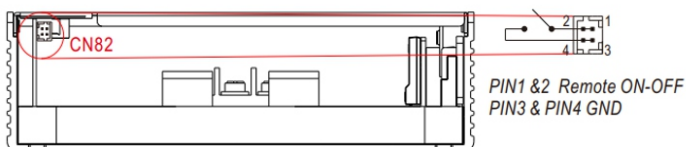

Remote ON-OFF	Power Supply Status
Short circuit	ON
Open circuit	OFF

B. CANBus Communication Interface

1. CANBus Communication Interface

⊙ Entity layer transport

This protocol adopts CAN ISO-11898 and the Baud rate is 250Kbps.

⊙ Protocol framework format

This protocol uses CAN 2.0B and uses the extended data frame transmission format

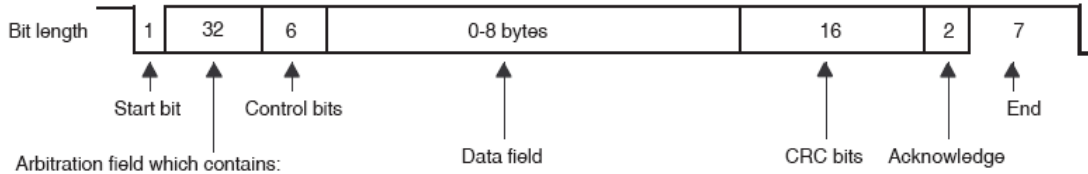

- 29-bit identifier + SRR bit + IDE bit + RTR bit for extended frame format

Where: RTR = Remote Transmission Request

SRR = Substitute Remote Request

IDE = Identifier Extension

⊙ Communication timing

Min. request period (Controller to UHP-1500-HV): 20mSec.

Max. response time (UHP-1500-HV to Controller): 5mSec.

Min. packet margin time (Controller to UHP-1500-HV): 5mSec.

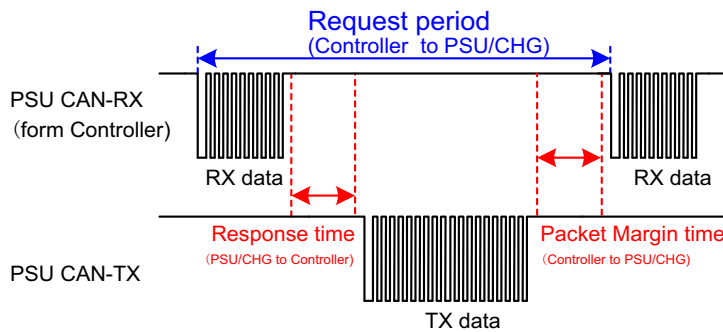

⊙ Data format

Controller to UHP-1500-HV

Write: Data filed bytes

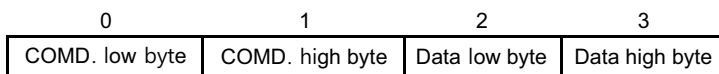

Read: Data filed bytes

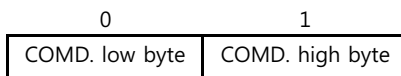

UHP-1500-HV to controller

Reply: Data filed bytes

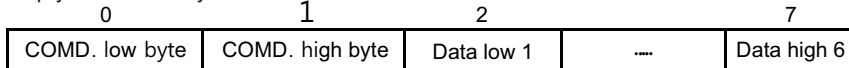

2. UHP-1500-HV Message ID definition description

Message ID	Narrate
0xC00XX	UHP-1500-HV to controller Message ID
0xC01XX	Controller UHP-1500-HV Message ID
0xC01FF	The Controller broadcasts the Message ID to the UHP-1500-HV



Module No.	Device address		
	A0	A1	A2
	DIP switch position		
	1	2	3
0	ON	ON	ON
1	OFF	ON	ON
2	ON	OFF	ON
3	OFF	OFF	ON

Module No.	Device address		
	A0	A1	A2
	DIP switch position		
	1	2	3
4	ON	ON	OFF
5	OFF	ON	OFF
6	ON	OFF	OFF
7	OFF	OFF	OFF

Table 2-1

3. CANBus command list

Command Code	Command Name	Transaction Type	# of data Bytes	Description
0x0000	OPERATION	R/W	1	Turn controls on/off
0x0020	VOUT_SET	R/W	2	Output voltage setting (format: value, F=0.01)
0x0030	IOUT_SET	R/W	2	Export current setting (format: value, F=0.01)
0x0040	FAULT_STATUS	R	2	Abnormal status
0x0050	READ_VIN	R	2	Input voltage readout (format: value, F=0.01)
0x0060	READ_VOUT	R	2	Output voltage readout (format: value, F=0.01)
0x0061	READ_IOUT	R	2	Output current readout (format: value, F=0.01)
0x0062	READ_TEMPERATURE_1	R	2	Internal ambient temperature reading (format: value, F=0.01)
0x0080	MFR_ID_B0B5	R	6	Manufacturer name
0x0081	MFR_ID_B6B11	R	6	Manufacturer name
0x0082	MFR_MODEL_B0B5	R	6	Manufacturer model name
0x0083	MFR_MODEL_B6B11	R	6	Manufacturer model name
0x0084	MFR_REVISION_B0B5	R	6	Firmware version
0x0085	MFR_LOCATION_B0B2	R/W	3	Place of manufacture
0x0086	MFR_DATE_B0B5	R/W	6	Date of manufacture
0x0087	MFR_SERIAL_B0B5	R/W	6	Manufacturing serial number
0x0088	MFR_SERIAL_B6B11	R/W	6	Manufacturing serial number
0x00C0	SCALING_FACTOR	R	2	Scale factor
0x00C1	SYSTEM_STATUS	R	2	System status
0x00C2	SYSTEM_CONFIG	R/W	2	System settings

Table 3-1

4. UHP-1500-HV CANBus value range and error

◎ Display parameters

CANBus Command		Model	Display value range	Tolerance
0x0050	READ_VIN	ALL	80~264V	±10V
0x0060	READ_VOUT	115V	0~138V	±1.15V
		230V	0~260V	±2.3V
		380V	0~400V	±3.8V
0x0061	READ_IOUT (Note.1)	115V	0~14.36A	±0.7A
		230V	0~7.7A	±0.4A
		380V	0~4.95A	±0.25A
0x0062	READ_TEMPERATURE_1	ALL	-40~100°C	±5°C

Table 4-1

◎ Control parameters

CANBus Command		Model	Display value range	Tolerance	Default
0x0000	OPERATION	ALL	00h(OFF)/01h(ON)	N/A	01h(ON)
0x0020	VOUT_SET	115V	57.5~138V	±1.15V	115V
		230V	108~260V	±2.3V	230V
		380V	167~400V	±3.8V	380V
0x0030	IOUT_SET	115V	2.61~13.05A	±0.7A	13.05A
		230V	1.4~7A	±0.4A	6.52A
		380V	0.9~4.5A	±0.25A	3.95A
0x00C2	SYSTEM_CONFIG	ALL	N/A	N/A	02h

Table 4-2

Note:

1.READ_IOUT will display ZERO amp when output current is less than values in the table below.

Model	Minimum readable current
115V	0.52A±0.1A
230V	0.28A±0.1A
380V	0.18A±0.1A

5. Definition and contents of CANBus Command list

◎ Definition of Command FAULT_STATUS(0x0040) :

Low byte	Bit7	Bit6	Bit5	Bit4	Bit3	Bit2	Bit1	Bit0
	HI_TEMP	OP_OFF	AC_FAIL	SHORT	OLP	OVP	OTP	FAN_FAIL

Bit 0 FAN_FAIL: Fan abnormal state

0 =The fan is normal

1 =The fan is abnormal

Bit 1 OTP : Overtemperature protection state

0 =Not protected against overtemperature

1 =It is protected against over temperature

Bit 2 OVP: Output overvoltage protection status

0 =Not in the output overvoltage protection

1 =Output overvoltage protection

Bit 3 OLP: Overload protection status

0 =Not in overload protection

1 =is under overload protection

Bit 4 SHORT: Short-circuit protection status

0 =Not in short-circuit protection

1 =Protected against short circuits

Bit 5 AC_FAIL: Input voltage abnormal protection status

0 =Non-input voltage anomaly protection

1 =Protection at input voltage abnormality

Bit 6 OP_OFF: Output off indication

0 =is on output

1 =is off at output

Bit 7 HI_TEMP: Warning of excessive ring temperature

0 =at normal ambient temperature

1 =At the ambient temperature is too high

Note: The displayed status is not supported, and the display is 0

© MFR_ID_B0B5(0x0080) is the first 6 yards of the manufacturer's name; MFR_ID_B6B11(0x0081) is 6 yards after the manufacturer's name (indicated in ASCII)

EX: THE MANUFACTURER MEANWELL MFR_ID_B0B5 MEANWE; The MFR_ID_B6B11 is LL

MFR_ID_B0B5					
Byte 0	Byte 1	Byte 2	Byte 3	Byte 4	Byte 5
0x4D	0x45	0x41	0x4E	0x57	0x45

MFR_ID_B6B11					
Byte 0	Byte 1	Byte 2	Byte 3	Byte 4	Byte 5
0x4C	0x4C	0x20	0x20	0x20	0x20

© MFR_MODEL_B0B5 is the first 6 yards of the model code; MFR_MODEL_(0x0082) B6B11(0x0083) is the model code after 6 yards (indicated by ASCII)

EX: Model UHP-1500 MFR_MODEL_B0B5 is UHP-1500; MFR_MODEL_B6B11 is 00-380

MFR_MODEL_B0B5					
Byte 0	Byte 1	Byte 2	Byte 3	Byte 4	Byte 5
0x55	0x48	0x50	0x2D	0x31	0x35

MFR_ID_B6B11					
Byte 6	Byte 7	Byte 8	Byte 9	Byte 10	Byte 11
0x30	0x30	0x2D	0x33	0x38	0x30

© MFR_REVISION_B0B5 (0x0084) can represent up to six MCU firmware versions (represented by Binary), where the order is coded by firmware part number in MCU number. The firmware version range of an MCU is 0x00(R00.0)~0xFE (R25.4), and the part without version is indicated by 0xFF.

EX: PSU products have six MCUs, MCU number 1 firmware version is R01.3 version (0x0D), firmware number 2 firmware version R01.2 (0x0C), firmware number 3 firmware version R01.1 (0x0B), and rest R01.0 version (0x0A)

Byte 0	Byte 1	Byte 2	Byte 3	Byte 4	Byte 5
0xFE	0x69	0xFF	0xFF	0xFF	0xFF

© MFR_DATE_B0B5(0x0086) is manufacture date (ASCII)

EX: MFR_DATE_B0B5 is 180101, meaning 2018/01/01

Byte 0	Byte 1	Byte 2	Byte 3	Byte 4	Byte 5
0x31	0x38	0x30	0x31	0x30	0x31

© MFR_SERIAL_B0B5 (0x0087) and MFR_SERIAL_B6B11 (0x0088) are defined as manufacture date and manufacture serial number (ASCII)

EX: The first unit manufactured on 2018/01/01→MFR_SERIAL_B0B5: 180101; MFR_SERIAL_B6B11: 000001

Byte 0	Byte 1	Byte 2	Byte 3	Byte 4	Byte 5
0x31	0x38	0x30	0x31	0x30	0x31

Byte 6	Byte 7	Byte 8	Byte 9	Byte 10	Byte 11
0x30	0x30	0x30	0x30	0x30	0x31

6. Communication example

6.1 Sending command

The master adjusts output voltage of the unit with address "01" to 330V.

CAN ID	DLC (data length)	Command code	Parameters
0xC0101	0x4	0x2000	E880

Command code: 0x0020 (VOUT_SET) → 0x20(Lo) + 0x00(Hi)

Parameters: 330V → 33000 → 0x80E8 → 0xE8(Lo) + 0x80(Hi)

NOTE: VOUT_SET conversion factor is 0.01, so $\frac{330V}{F=0.01} = 33000$

6.2 Reading data or status

The master reads operation setting from the unit with address "00".

CAN ID	DLC (data length)	Command code
0xC0100	0x2	0x0000

The unit with address "00" returns data below

CAN ID	DLC (data length)	Command code	Parameters
0xC0000	0x3	0x0000	0x01

Parameters: 0x01 ON, which stands for operation on the "00" unit.

6.3. Practical Operation

The following steps will describe how to set the UHP-1500-380 to 330V .

1. Set the address of the charger to "0", Refer to Table 2-1.
2. Connect the CANH/CANL pins of the master to the corresponding CANH(PIN7) and CANL(PIN8) pins of the CN77 connector on the supply. It is recommended to establish a common ground for the communication system to increase its communication reliability by using GND-AUX(PIN3&4) of CN77

⊙ Set baud rate: 250kbps, type: extended.

⊙ Adding a 120Ω terminal resistor to both the controller and rack shelf ends can increase communication stability.



3. Communication function can be accessed immediately after UHP-1500-380 is connected to AC. Set output voltage at 330V.

CAN ID	DLC(data length)	Command Code	Parameters
0XC0100	0X04	0X2000	E880

Command code: 0x0020(VOUT_SET)

Data: 330V → 33000 → 0x80E8 → 0xE8(Lo) + 0x80(Hi)

NOTE: VOUT_SET conversion factor is 0.01, so $\frac{330V}{F=0.01} = 33000$

4. It is recommended to review all of the settings and parameters using the appropriate commands. In the event that they do not meet your requirements, you may rewrite them as needed.

EX: Read VOUT_SET to check whether output voltage was set to a proper level.

Read VOUT_SET

CAN ID	DLC(data length)	Command Code
0XC0100	0X04	0X2000

The unit returns data below

CAN ID	DLC (data length)	Command code	Parameters
0xC0000	0x04	0x2000	E880

Data: 0XE8(Lo) + 0x80(Hi) → 0xE880 → 33000 = 330V.

5. Finally, if the power supply has no output, please confirm that the Remote ON-OFF pin of the CN82 is shorted with PIN3&PIN4 (GND). Also please make sure command sending/reading is in an interval of below 4 sec in order not to trigger

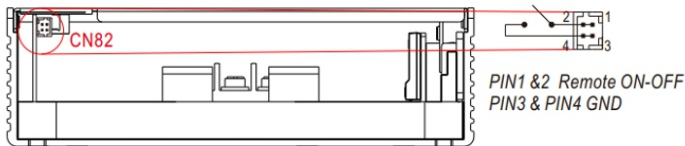

Remote ON-OFF	Power Supply Status
Short circuit	ON
Open circuit	OFF

C.Factory Resetting

1.PMBus: Users can follow the steps below to restore factory settings for commands: 01h, 22h, 46h and BEh.

- ① Set DIP switch all in the "ON" position.
- ② Turn on the AC without remote on, there should be no voltage at the output.
- ③ Within 15 seconds, set DIP switch all in the "OFF" position and all back in the "ON" again.
- ④ The green LED flashing 3 times means the process is successfully done.
- ⑤ Restart the supply to load factory settings.

2.CANBus: Users can follow the steps below to restore factory settings for commands: 0x0000, 0x0020, 0x0030, 0x00C2.

- ① Set DIP switch all in the "ON" position.
- ② Turn on the AC without remote on, there should be no voltage at the output.
- ③ Within 15 seconds, set DIP switch all in the "OFF" position and all back in the "ON" again.
- ④ The green LED flashing 3 times means the process is successfully done.
- ⑤ Restart the supply to load factory settings.

明緯企業股份有限公司

MEAN WELL ENTERPRISES CO., LTD.

248 新北市五股區五權三路28號

No.28, Wuquan 3rd Rd., Wugu Dist., New Taipei City 248, Taiwan

Tel: 886-2-2299-6100 Fax: 886-2-2299-6200

<http://www.meanwell.com> E-mail: info@meanwell.com

Your Reliable Power Partner